

komfovent[®]

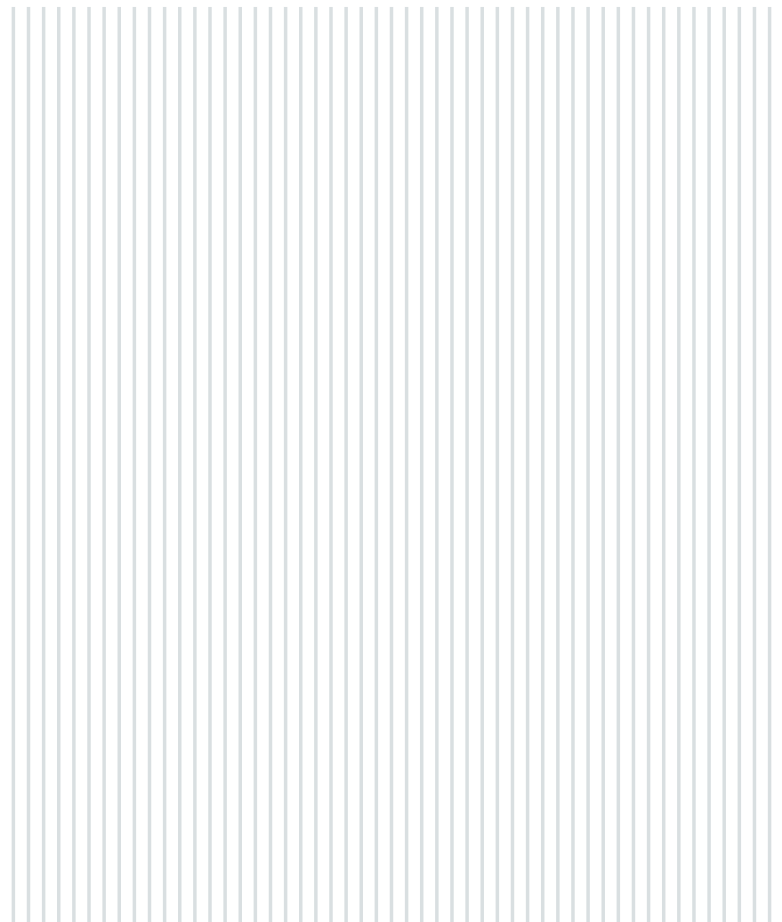

DOMEKT

C8 automation

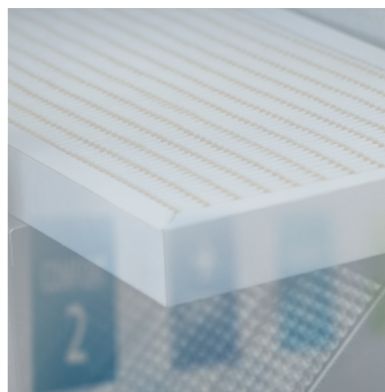

USER
MANUAL

EN











CONTENT

| | |
|---|----|
| 1. INTRODUCTION | 4 |
| 2. AIR HANDLING UNIT FUNCTIONS | 4 |
| 2.1. Temperature control..... | 4 |
| 2.2. Standard operating modes..... | 5 |
| 2.3. Special operating modes..... | 5 |
| 2.4. ECO mode | 6 |
| 2.5. AUTO mode | 6 |
| 2.5.1. Weekly operation schedule..... | 6 |
| 2.5.2. Air quality control function | 6 |
| 3. CONTROL AND SETTINGS | 8 |
| 3.1. Control panel C6.1..... | 8 |
| 3.1.1. Parameter overview | 10 |
| 3.1.2. Turning on | 10 |
| 3.1.3. Turning off | 11 |
| 3.1.4. Mode change | 11 |
| 3.1.5. Air quantity and temperature settings | 12 |
| 3.1.6. Air quality control mode activation and settings | 13 |
| 3.1.7. ECO mode activation and settings | 14 |
| 3.1.8. Creating a weekly operation schedule | 14 |
| 3.1.9. Main settings..... | 16 |
| 3.1.10. Advanced settings | 17 |
| 3.1.11. Alarms..... | 21 |
| 3.1.12. About device..... | 21 |
| 3.2. Control panel C6.2..... | 22 |
| 3.2.1. Turning on/off and changing operation modes..... | 22 |
| 3.2.2. Messages..... | 22 |
| 3.2.3. Control panel sounds | 22 |
| 3.2.4. Keypad lock..... | 23 |
| 3.3. Control via smartphone | 23 |
| 3.3.1. Connection to the air handling unit with a "Komfovent Control" app | 23 |
| 3.4. Control via computer | 25 |
| 3.4.1. Turning on/off and changing operation modes..... | 27 |
| 3.4.2. Parameter overview | 28 |
| 3.4.3. Air quantity and temperature settings | 29 |
| 3.4.4. ECO and AUTO mode settings | 30 |
| 3.4.5. Ventilation by a weekly schedule..... | 30 |
| 3.4.6. Creating a weekly schedule | 31 |
| 3.4.7. Alarms | 32 |
| 3.4.8. Settings..... | 33 |
| 4. TROUBLESHOOTING | 36 |
| 4.1. Table of messages | 37 |
| 4.2. Table of light indicators of the C6.2 control panel..... | 39 |
| 5. PERIODICAL MAINTENANCE | 40 |
| 5.1. Filter inspection and replacement | 41 |
| 5.2. Device maintenance journal | 43 |
| APENDIX NO.1. KOMFOVENT CONTROL Terms of Use and Privacy Notice | 44 |

1. INTRODUCTION

The air handling unit is designed to ensure good ventilation of premises. Air handling unit removes indoor air containing carbon dioxide, various allergens or dust, while replacing it with filtered fresh air from outside. As the outside air is usually colder or warmer than the air within the premises, an integrated recuperator collects thermal energy from the indoor air and transfers the majority of it to the supply air.

When a recuperator is not capable of reaching a desired temperature, heaters or coolers may be additionally activated.¹

| | | |
|---|--|---|
|  | The operation, maintenance or repair of the air handling unit is prohibited for people (including children) with mental, physical or sensory disabilities, as well as for persons without sufficient experience and knowledge, unless supervised and instructed by the person responsible for their safety in accordance with these instructions. |  |
|  | Heat exchangers and heaters (or coolers) are designed to compensate for heat/cool losses during ventilation, therefore, we do not recommend using the unit as the main heating/cooling source. The unit may not reach a user-defined supply air temperature when the actual room temperature differs significantly from the desired room temperature. This will lead to inefficient operation of a heat exchanger. |  |
|  | Make sure that the unit is installed in a designated location, all ducts and wires are connected before turning it on. Check for foreign objects, debris or tools inside the unit. Make sure that air filters are installed and condensate drainage is connected (if necessary). If in doubt, contact your installer or "Komfovent" representative to make sure that the unit is operational. |  |
|  | We recommend that you always keep your device turned on; when no ventilation is required, you shall operate the unit in a minimum mode (20%). This will ensure good indoor climatic conditions and will reduce humidity condensation inside the unit, that may damage electronic components. |  |
|  | Make sure that children will not reach and will not play with air handling unit without adult supervision. |  |



This symbol indicates that this product is not to be disposed of with your household waste, according to the WEEE Directive (2002/96/EC) and your national law. This product should be handed over to a designated collection point, or to an authorised collection site for recycling waste electrical and electronic equipment (EEE). Improper handling of this type of waste could have a possible negative impact on the environment and human health due to potentially hazardous substances that are generally associated with EEE. At the same time, your cooperation in the correct disposal of this product will contribute to the effective usage of natural resources. For more information about where you can drop off your waste equipment for recycling, please contact your local city office, waste authority, approved WEEE scheme or your household waste disposal service.

2. AIR HANDLING UNIT FUNCTIONS

To create a comfortable home environment, you can adjust ventilation intensity and air temperature as well as to create a weekly ventilation schedule. Various additional functions facilitate control of all ventilation processes and reduce electricity consumption.

2.1. Temperature control

Temperature in the air handling unit is maintained by measuring the actual temperature and comparing it to the user-defined temperature. Then, depending on whether the supply air requires heating or cooling, heat exchanger or additional heaters/coolers are activated. Available temperature control methods:

- **Supply** air temperature control – the unit supplies air of user-defined temperature.
- **Extract** air temperature control – the unit automatically selects the supply air temperature to ensure that the extract air temperature is reached and maintained as quickly as possible. Room air temperature is measured by an integrated extract air temperature sensor.

¹ Depends on the equipment supplied.

- **Room** temperature control – the unit automatically selects the temperature of supply air to ensure that the room temperature is reached and maintained as measured by the sensor integrated in a remote controller. Control panel must be installed in a room where temperature maintenance is required.
- **Balance** – Supplied air temperature will be maintained to be the same as extracted air temperature, therefore, selecting a desired temperature is not possible. Extract air temperature is measured by an integrated extract air temperature sensor.







To maximize heating/cooling energy savings, priority is always given to the heat exchanger, so due to its high efficiency, there may be cases where slightly warmer (heating mode) or colder (cooling mode) than user set temperature air will be supplied.



Selection of temperature control is described in chapter “Control and Settings”.

2.2. Standard operating modes





4 standard operating modes are available on your air handling unit. Each operating mode has preset air volume and desired temperature values:

| |  AWAY |  NORMAL |  INTENSIVE |  BOOST |
|-----------------------|--|--|---|---|
| Ventilation intensity | 20% | 50% | 70% | 100% |
| Set temperature | 20°C | 20°C | 20°C | 20°C |

These settings may be changed (see “Control and Settings”).

2.3. Special operating modes

4 special operating modes are available on your air handling unit. During activation, KITCHEN, FIREPLACE and OVERRIDE modes are set for operation from 1 min. to 300 min. In HOLIDAY mode, operation time is set from 1 to 90 days or for a specific date. OVERRIDE mode may also be activated by short-cutting designated terminal on the main board, i.e. by connecting a switch, cooker hood or a motion sensor (see “Installation Manual”). Each operating mode has preset air volume and desired temperature values:

| |  KITCHEN |  FIREPLACE |  OVERRIDE |  HOLIDAYS |
|---------------------------|---|---|--|--|
| Intensity of supplied air | 80% | 60% | 80% | Ventilation unit will turn on for 30 minutes several times a day. At other times, the ventilation unit is switched off. Ventilation intensity 20%. |
| Intensity of extract air | 20% | 50% | 80% | |
| Set temperature | 20°C | 20°C | 20°C | 20°C |

These settings may be changed (see “Control and Settings”).

2.4. ECO mode

ECO – an energy saving mode intended for minimizing power consumption. Power consumption is reduced by turning off heating/cooling devices, making maximum use of outdoor air or decreasing fan speed. During ECO mode:

- Electrical heater is blocked, all other external air heating/cooling devices are switched off.
- Rooms are cooled/heated with the outside air without a recuperator when the outside air temperature falls within the set temperature range.
- When supply air temperature is below a set minimum value (in winter) or exceeds a maximum value (in summer), the unit attempts to maintain the air temperature by decreasing ventilation intensity.

Setting the temperature range, switching off recuperation or heating/cooling devices may be done in the ECO mode settings (see chapter “Control and Settings”).

2.5. AUTO mode

During AUTO mode, ventilation intensity is adjusted by a weekly schedule or air quality in the premises, i.e. ventilation is activated only when necessary or desired.

2.5.1. Weekly operation schedule

If you want the unit to operate when you need it, you can create a weekly operation schedule. The unit has 3 default weekly operation schedules tailored to different situations. Also, you can create your own schedule:

| Working week | Office | Stay at home |
|--|---|--|
| At night the unit operates in <i>AWAY</i> operation mode, and in the morning or evening it switches to <i>NORMAL</i> operation mode. The unit is switched off during the working day. | The unit operates only during the working days: in <i>NORMAL</i> operation mode until noon and in <i>INTENSIVE</i> mode in the afternoon. The unit is switched off during nights and weekends. | The unit operates all the time: in <i>AWAY</i> operation mode during the night and in <i>NORMAL</i> operation mode during the day. |

Programs, times and days of a schedule may be changed (see chapter “Control and Settings”).

2.5.2. Air quality control function

Air quality control function activates ventilation only when necessary, i.e. when the air quality is poor. If the indoor air quality is good, the unit will ventilate at minimum speed or stop. Air quality in the premises may be controlled by impurity or humidity sensors connected to B8 terminal (see “Installation Manual”).

As air impurity and humidity control methods slightly differ, the air quality control function is divided into:

- **Impurity control**
Impurity function is controlled via the following sensors:
CO₂ – carbon dioxide concentration sensor [0...2000 ppm];
VOC – air quality sensor [0...100 %];

Air impurity function automatically selects ventilation intensity in the range of 20–70%, based on air quality readings. If air pollution is within the user-defined limits, fans will operate at minimum speed; as level of pollution increases, the unit will increase ventilation speed and supply more fresh air to the premises. It is also possible to stop the unit when air pollution is low. For this purpose, change a minimum ventilation intensity limit to 0% (see “Control and Settings”). Then the unit will turn on periodically (every 2 hours by default) to inspect the air quality, and will ventilate until pollution is reduced, if necessary.

Type of connected sensors and range of ventilation intensity may be modified (see “Control and Settings”).

- **Humidity control**

Humidity control function allows dehumidification of air in the premises. Possible ways of dehumidification:

1. If outdoor humidity is measured via an additional humidity sensor, air in the premises will be dehumidified when humidity level outdoors is lower than indoors. Indoor humidity is monitored by a integrated in a control panel. In the settings: set sensor type RH and select one of the connected sensors for measuring outdoor humidity (see “Control and Settings”). In AUTO mode fans are running at minimum speed as long as the indoor humidity is lower than the setpoint (see “Impurity Control”). When humidity outdoors is lower than indoors and dehumidification of the premises is necessary, the fan speed will be increased gradually and drier air will be supplied.
2. If no outdoor humidity sensor is used, “Humidity Control” function operates the same way as the “Impurity Control” function but instead of an air quality sensor, optional humidity sensor connected to the controller or integrated in the control panel is used.
3. If an external DX unit or a water cooler is used (activated in “Control Sequence Settings”), additional dehumidification is possible by cooling supply air. In this case, the supply air temperature setpoint is ignored and colder but drier air is supplied until the desired indoor humidity level is reached. If an outdoor humidity sensor is used and the outdoor air is drier, the unit will attempt lowering the indoor humidity by supplying drier outdoor air before activating cooling units. Dehumidification with cooling devices is possible both in AUTO and standard ventilation modes.

To use a DX unit or a water cooler for dehumidification of supply air, activate an option “Allow dehumidifying with cooling” (see “Control Sequence Settings”). An option to enter a value for desired humidity will appear in the settings of standard ventilation modes.



On units with a rotary heat exchanger, the air quality function may be temporarily stopped while the icing protection is in operation.



3. CONTROL AND SETTINGS

Ventilation unit may be conveniently controlled via the following ways:

- Remote controller
- Mobile app
- Web browser

Air handling unit (based on its equipment) may have one of the following control panels:

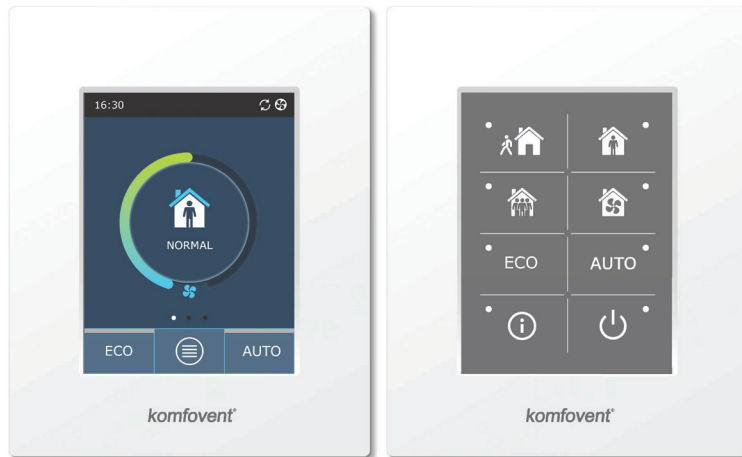

C6.1

C6.2





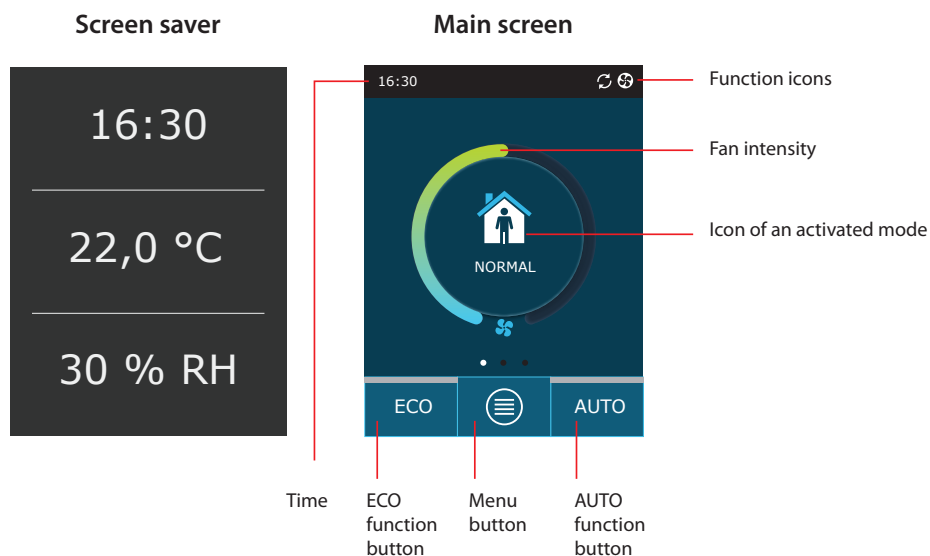

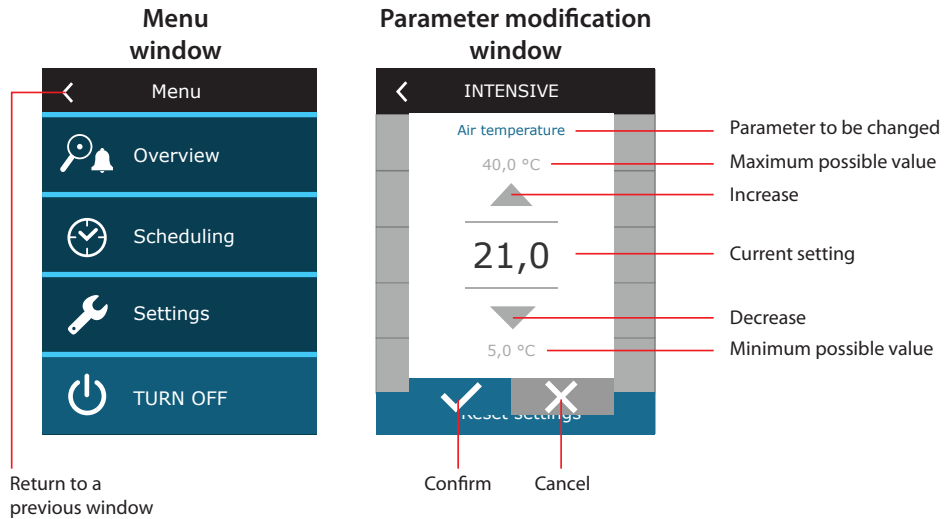







3.1. Control panel C6.1

Panel with a colour touch-sensitive display. This control panel is designed for indication and changing of various functions and settings of the unit. If the unit is connected to the mains, the control panel will display home screen or a screen saver that you can switch off with a single tap. Touch-sensitive display reacts to soft taps, therefore, do not use any sharp tools (screwdrivers or pens), also do not apply excessive force as it may damage the display.





Displayed symbols on the panel

| | | | |
|---|---|---|--|
|  | Fan operation |  | ECO mode on. Free cooling operation. |
|  | Energy recovery operation |  | ECO mode on. Free heating operation. |
|  | Air heater operation |  | Alarm signal (see the troubleshooting section) |
|  | Air cooler operation |  | Supply air |
|  | There is a heating demand, but it is being blocked by the ECO mode |  | Exhaust air |
|  | There is a cooling demand, but it is being blocked by the ECO modes |  | Outside air temperature |
|  | Air flow reduction. |  | Air filters |

3.1.1. Parameter overview

Swipe the main window to the side to see various parameters: air flow, temperatures, filter contamination, energy recovery and power consumption.

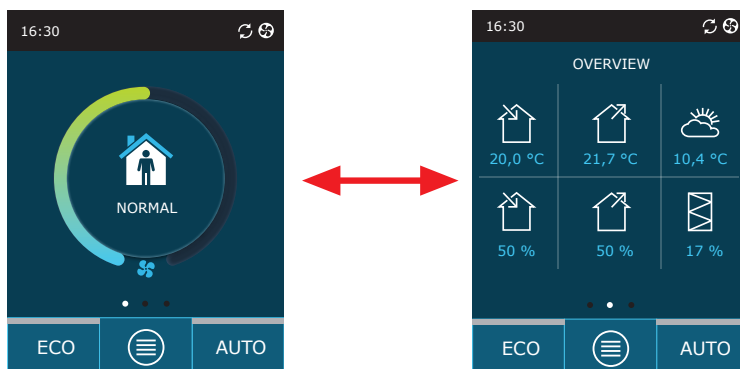

See menu section "Overview" for more parameters.

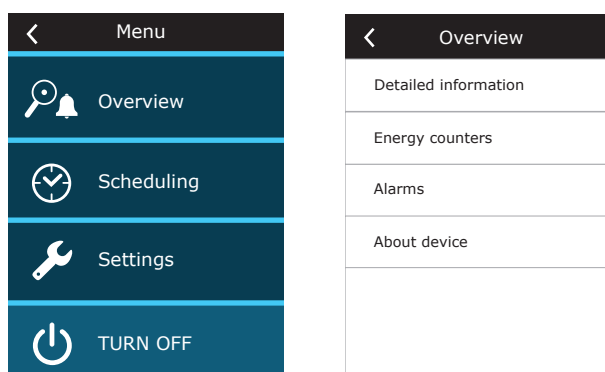

3.1.2. Turning on

The unit must be switched on to operate by a selected ventilation mode, schedule or air quality.

To turn on your air handling unit:

1. Press the ON/OFF button in the centre of the home screen.
2. Confirm the message that appears.
3. A symbol will appear in the centre of the home screen indicating an operating mode which will start soon.

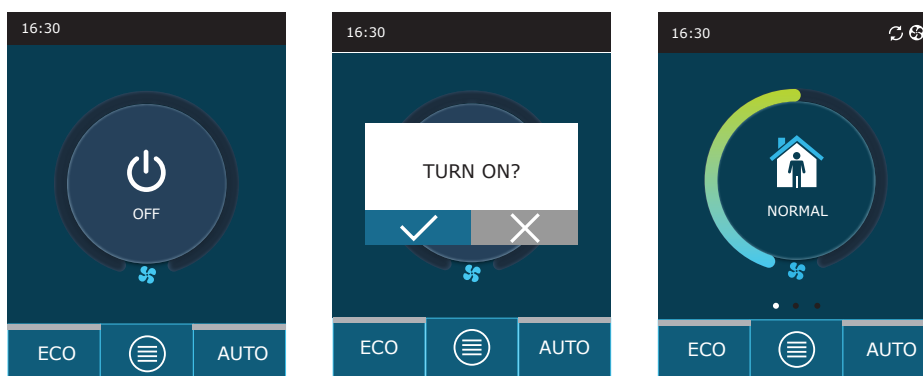

3.1.3. Turning off

If you want your device to stop working, regardless the operation schedule and other functions, you can turn it off. To turn off the device:

1. Press "Menu" button at the bottom of the home screen.
2. Press the ON/OFF button at the bottom of the menu window.
3. Confirm the message that appears.
4. Press a return icon at the top of the window to return to the main screen.

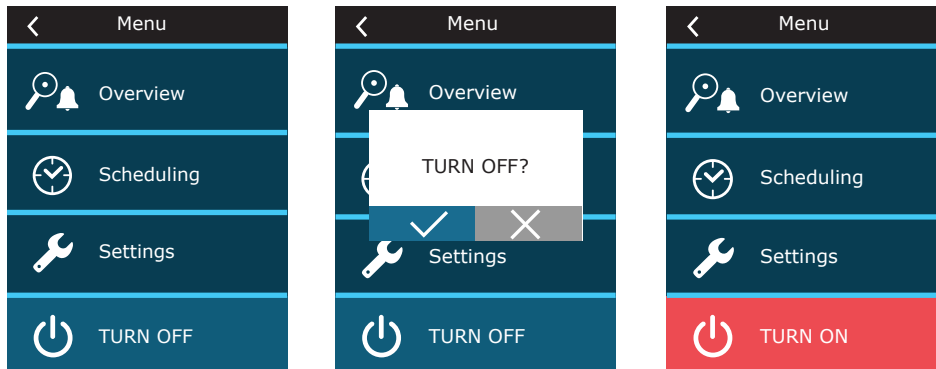

3.1.4. Mode change

To turn on a standard ventilation mode:

1. Press an icon indicating the current operation mode in the middle of the home screen.
2. Select and press a desired operation mode.
3. An icon for the selected operation mode appears in the middle of the home screen.

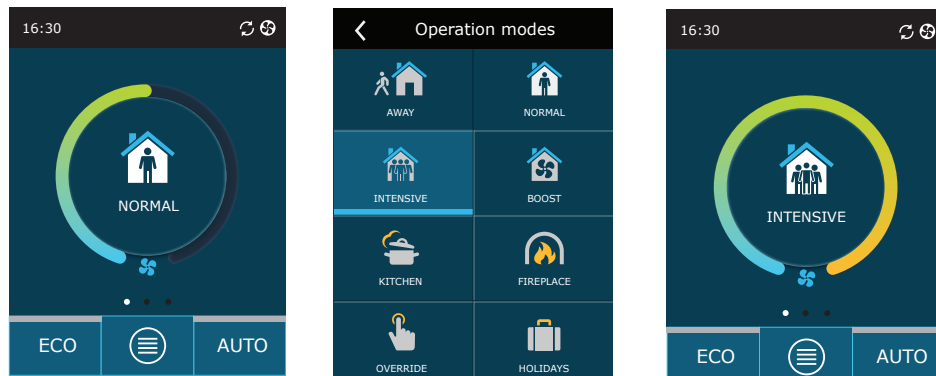

To turn on a **special ventilation mode**:

1. Press an icon indicating the current operation mode in the middle of the home screen.
2. Select and press a desired special operation mode.
3. Use the arrows to select desired operation duration and press to confirm.
4. Press the return icon at the top of the screen to return to the home screen.

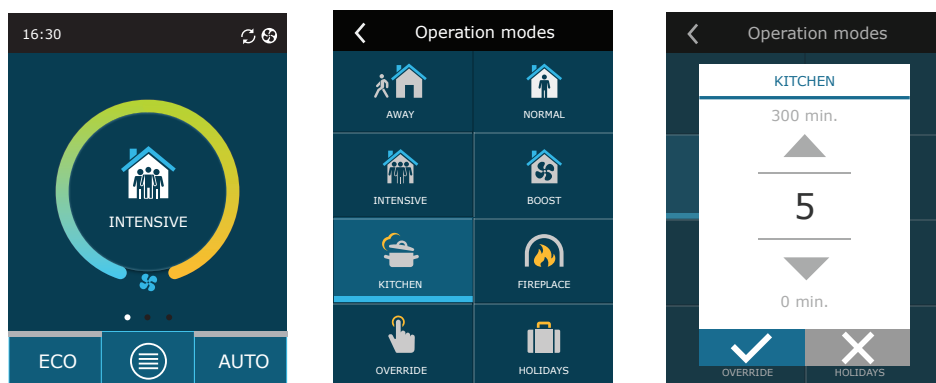

To activate ventilation by a weekly schedule¹:

1. Press "Menu" button at the bottom of the home screen.
2. Press "Planning" button in the menu window.
3. Use the arrows at the bottom of the window to select a desired weekly schedule.
4. Press a return icon at the top of the window twice to return to the home screen.
5. Press AUTO button to activate scheduled ventilation.
6. Information about upcoming changes in the schedule is displayed at the top of the screen.

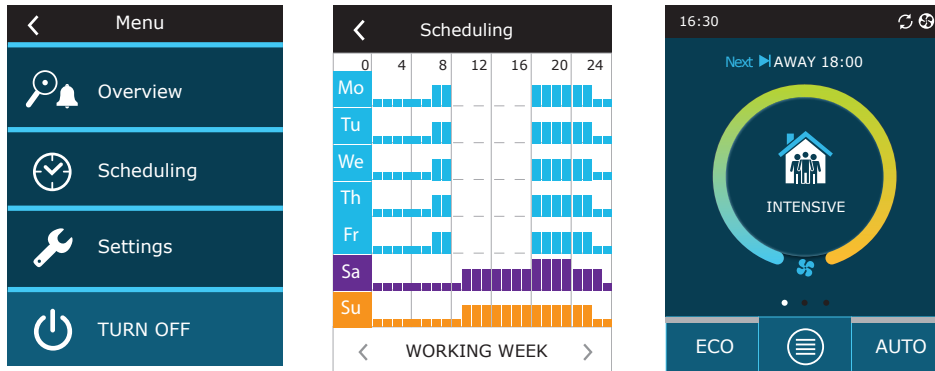

3.1.5. Air quantity and temperature settings

You can set air flow for supply and exhaust air, desired temperature and turn off/on an electric heater for each ventilation mode. If turned off, the heater will not turn on even when the desired temperature is not reached. If turned on, the heater will operate only when a heat exchanger alone cannot reach the set temperature.

To change the ventilation mode settings:

1. Press an icon indicating the current operation mode in the middle of the home screen.
2. Press a desired mode button and hold it for 5 seconds.
3. Press a parameter you want to change.
4. Use the arrows to select a desired value and press to confirm.
5. Press a return icon at the top of the screen to return to the home screen.

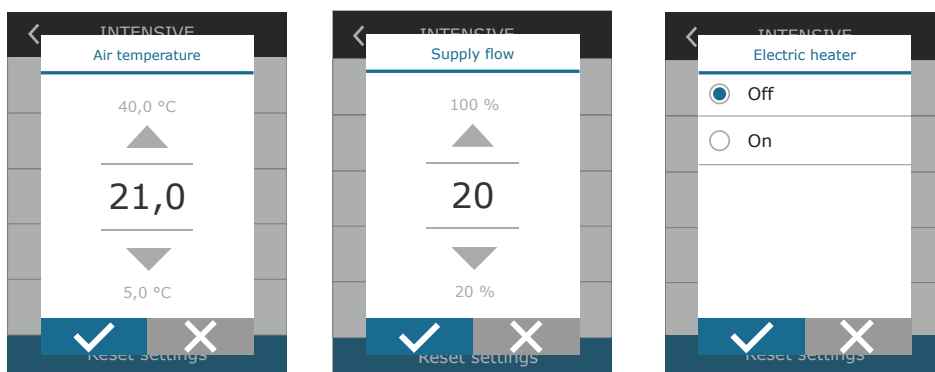
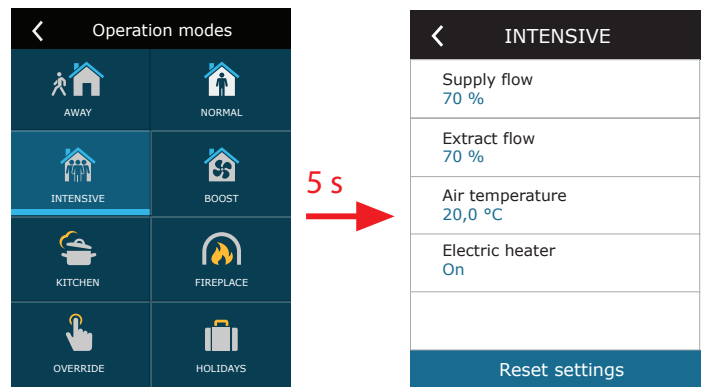

¹ Ventilation by a weekly schedule is not possible when air quality control function is activated.

3.1.6. Air quality control mode activation and settings

If air quality sensors are connected to the main board or impurity control/moisture control function is activated (see “Advanced Settings”), button “Scheduling” appears instead of “Air quality” button. For more information about the air quality control function see chapter “Air Quality Control Functions”.

To enter desired limits and turn on ventilation by air quality:

1. Press “Menu” button at the bottom of the home screen.
2. Press “Air quality” button.
3. Select a parameter you want to change.
4. Use the arrows to select a desired value and press to confirm.
5. Press a return icon at the top of the screen to return to the home screen.
6. Ventilation by air quality is turned on by pressing AUTO button while the unit is operating in any ventilation mode.
7. If the unit was stopped, pressing AUTO button will call up a message, the confirming of which will activate ventilation by air quality.

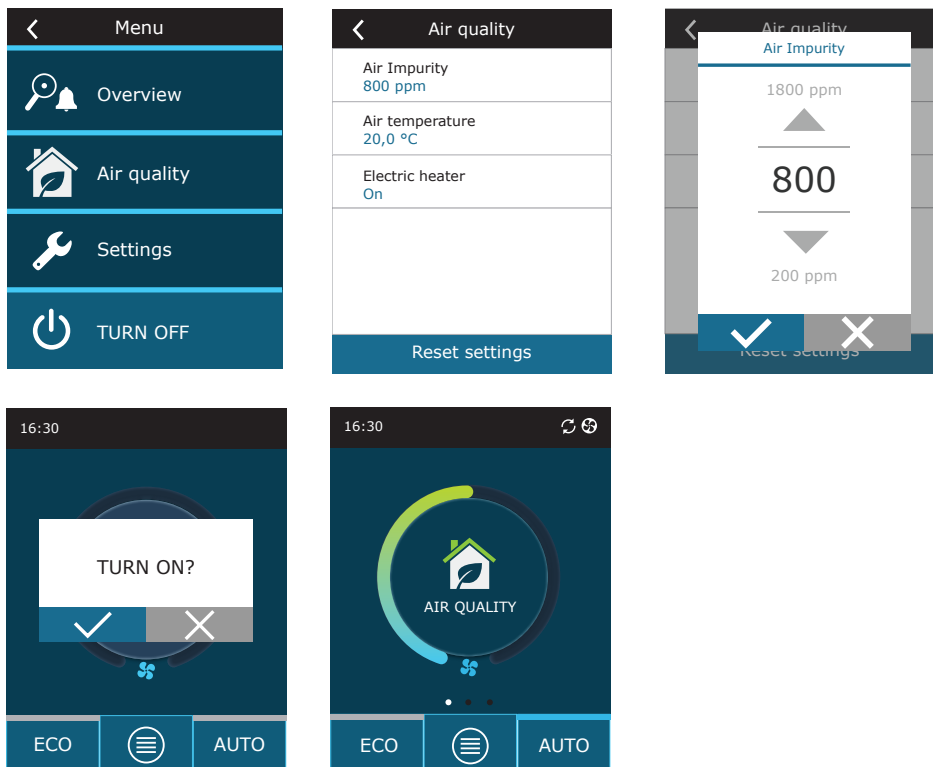

3.1.7. ECO mode activation and settings

ECO mode may be activated in any ventilation mode by pressing ECO button at the bottom of the home screen. For more information about the ECO mode see chapter "Air Quality Control Functions".

To change the ECO mode settings:

1. Press ECO button and hold it for 5 seconds.
2. Press a parameter you want to change.
3. Select a desired option or set a desired value using arrows.
4. Confirm your selection.
5. Press a return icon at the top of the window to return to the home screen.

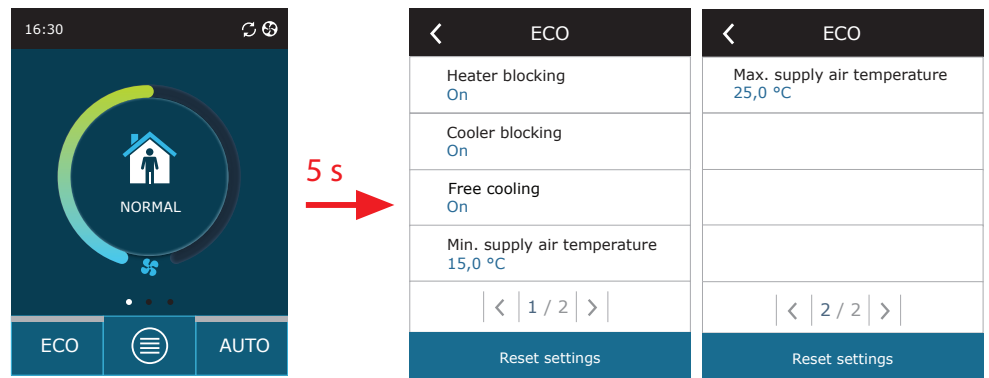

3.1.8. Creating a weekly operation schedule

You can modify ventilation modes, operation time and day for all default operation schedules.

To modify settings of a default schedule:

1. Select a weekly schedule as shown in Chapter "Mode Change".
2. Press the centre of the schedule window and hold for 5 seconds.
3. By pressing the weekday row you can select which days of the week this schedule sheet is valid for.
4. Pressing the ventilation mode icon on the left will allow selecting a desired ventilation mode.
5. Press time of a specific ventilation mode to change the operation start and end times.
6. Press X on the right to delete a row (ventilation mode and operation start/end times) from a schedule.
7. To add an additional row, press + under the last scheduled row (maximum 5 rows). If the last event ends at 24:00, you will have to delete it to add a new row.
8. To add another sheet, press + at the bottom of the window (maximum 4 sheets).

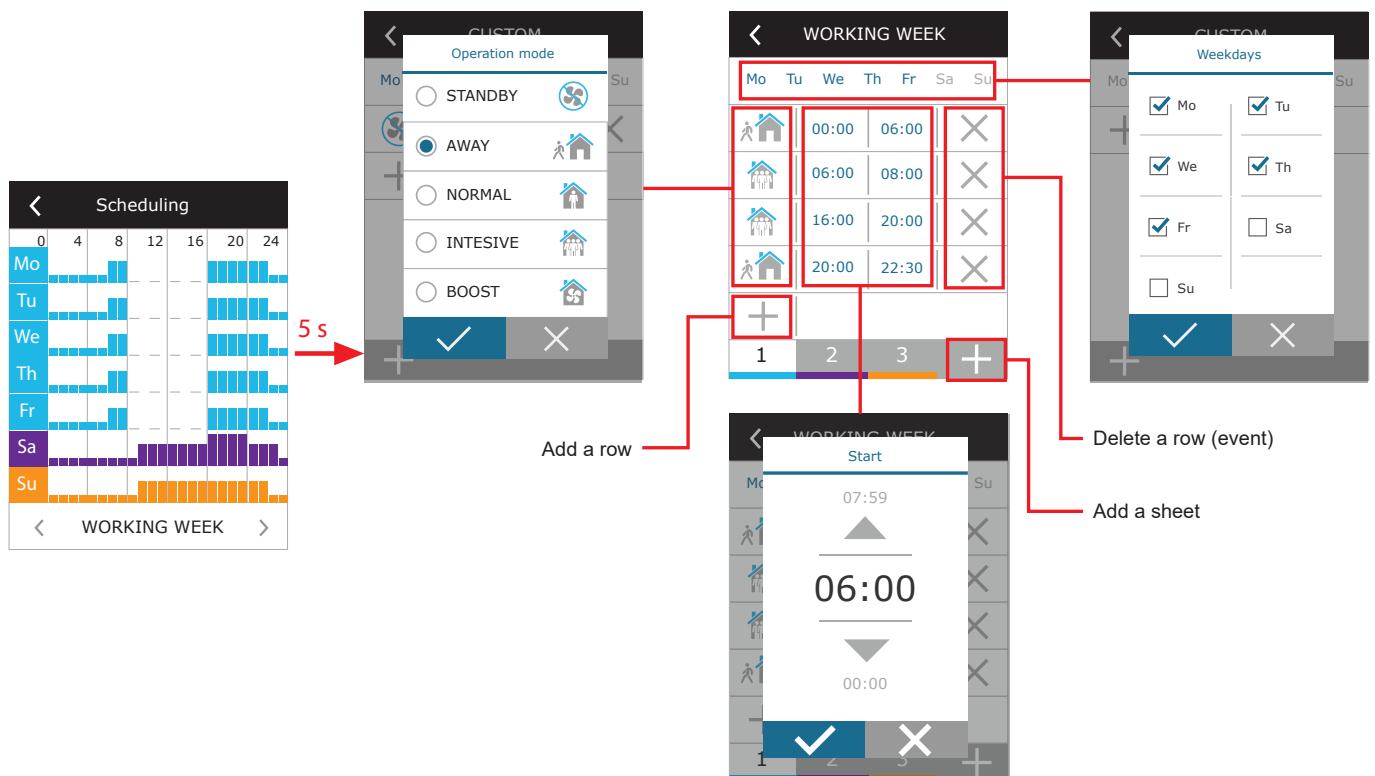

To create a weekly operation schedule:

1. Select a weekly schedule "My week" as shown in Chapter "Mode Change".
2. Press the centre of the schedule window and hold for 5 seconds.
3. Press the weekday row to select which days of the week this schedule sheet is valid for.
4. Press + symbol and add a new row.
5. Press the ventilation mode icon on the left to select a desired ventilation mode. There is no need to include a STANDBY mode in the schedule for intervals when the unit will not operate. The unit will be stopped during any intervals for which no ventilation mode is assigned.
6. Set the start and end time for a ventilation mode. If you need 24-hour ventilation, set the start time for 0:00 and the end time for 24:00.
7. To add an additional row, press + under the last scheduled row (maximum 5 rows). If the last event ends at 24:00, you will have to delete it to add a new row.
8. To add another sheet, press + at the bottom of the window (maximum 4 sheets).

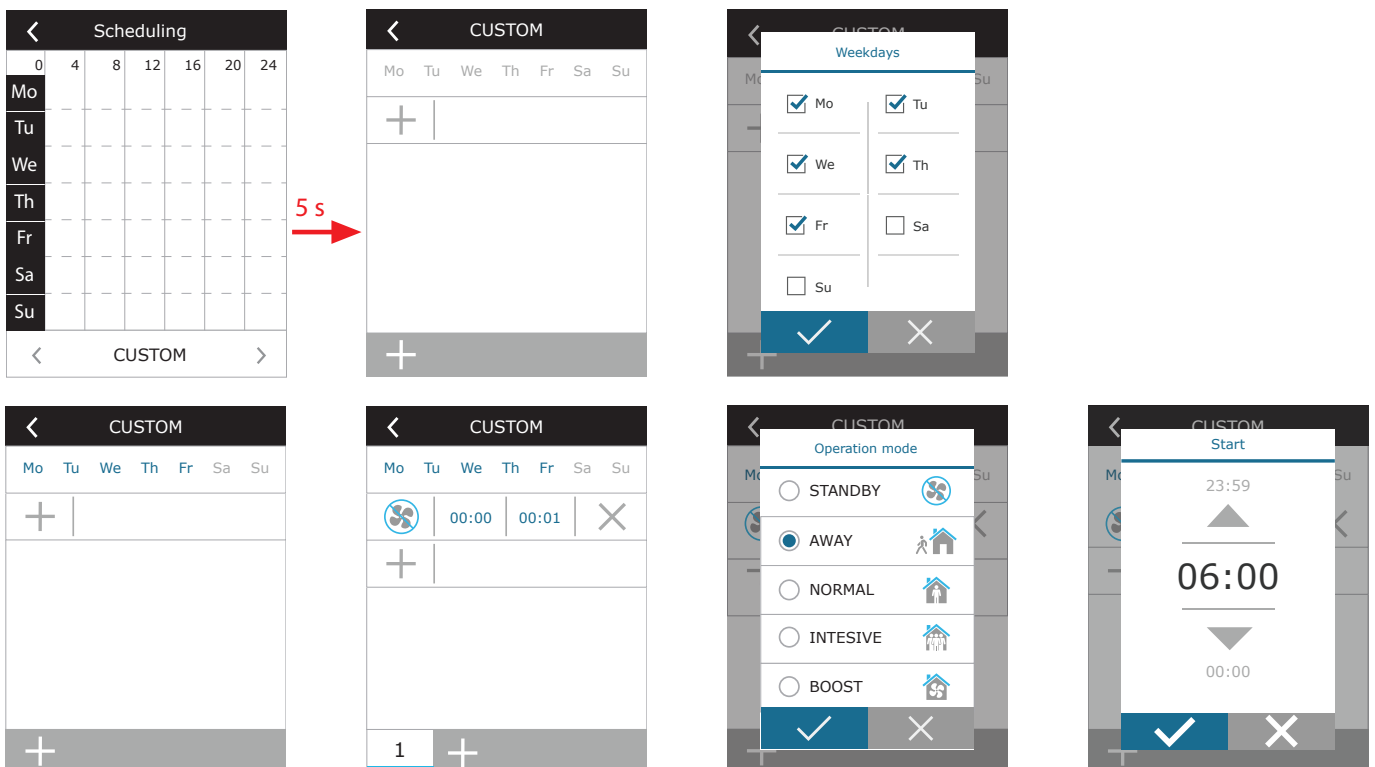

3.1.9. Main settings

In the menu point SETTINGS you can modify the main user interface settings:

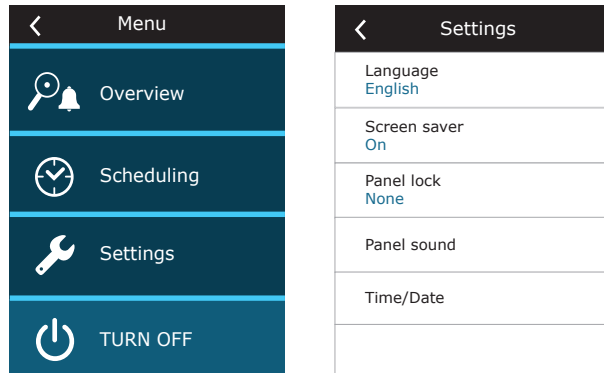

Language – set a desired control panel language using arrows.

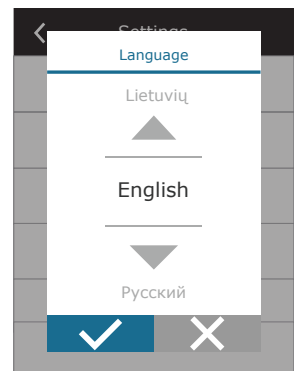

Screen saver – turn the screen saver on/off. Screen saver activates when a control panel is not used for longer than 1 min. You may select brightness of a screen saver, as well as settings and the order in which they are displayed. If a screen saver is deactivated, the control panel display turns off if not used for longer than 1 min. Tap a screen to wake-up.

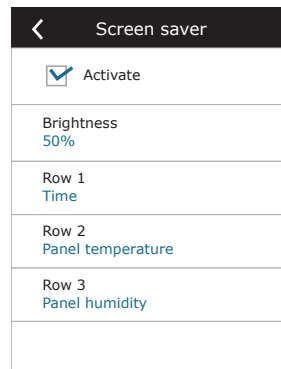

Panel lock – partial or full panel lock is available. Partial lock allows turning on/off an air handling unit and selecting desired ventilation mode but does not allow any ventilation settings to be changed. Full panel lock prevents the user from using the control panel. To unlock the panel, you have to enter your four-digit PIN code. When the lock is on, the panel will lock every time the screen saver is activated.

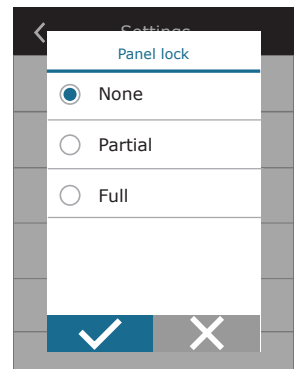

Panel sound – turning on/off touch and message sounds.

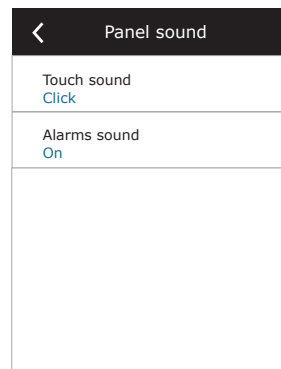

Time/Date – setting the time and date that are used for a weekly operation schedule or other functions.

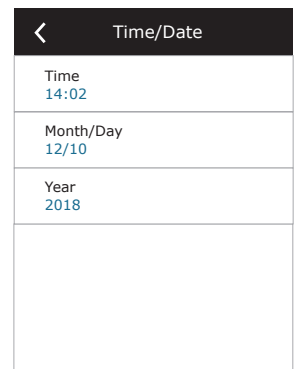

3.1.10. Advanced settings

To access the advanced settings, press and hold the SETTINGS button for 5 seconds.

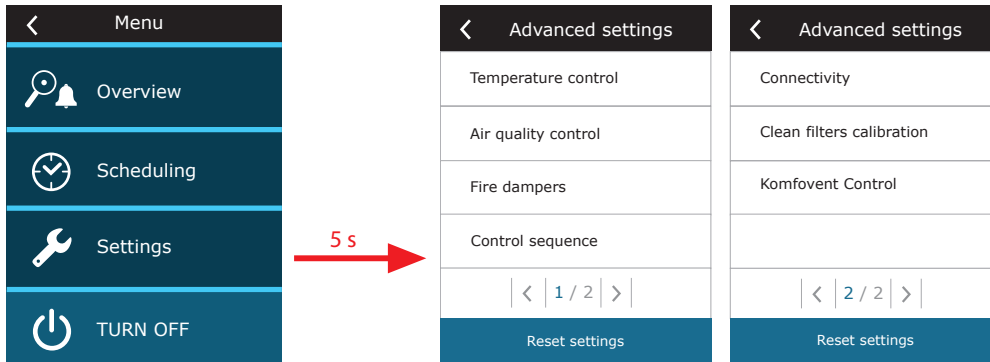

Temperature control – select a method for temperature control (see Chapter 2.1).

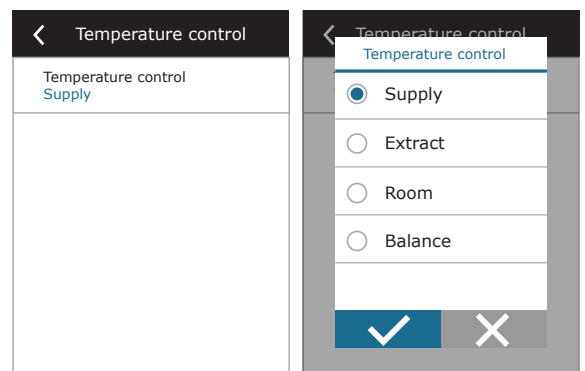

Air quality control – here you can activate and set-up air quality control which will be used in AUTO mode (see Chapter 2.5.2).

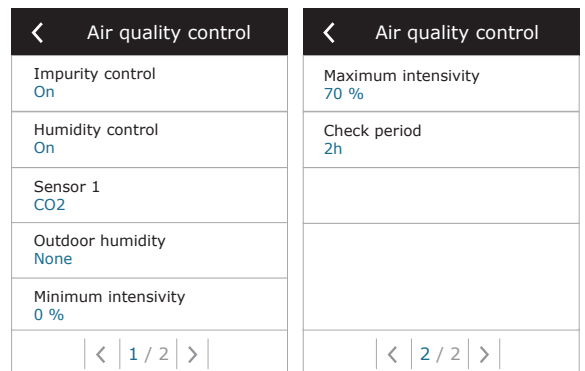

- **Impurity control** – turning on/off an impurity control function. At least one CO2 or VOC sensor must be connected to the controller board to activate this function (see Chapter 2.5.2.). If ventilation by a weekly schedule is required, this function must be turned off.
- **Humidity control** – turning on/off a humidity control function. Humidity control function requires a humidity sensor. If no humidity sensor is connected to the controller board, sensor integrated in a control panel will be used for this purpose (see Chapter 2.5.2.).
- **Sensor 1** – specify the type of the sensor connected to a terminal B8 (see “Installation Manual”). If this sensor is not available, select “None”.
- **Outdoor humidity** – this option appears when one of the sensors is of RH type (humidity sensor). If any of the connected sensors are installed in the outdoor air flow, specify which one. If none of the installed humidity sensors measure the outside humidity, select “None”.

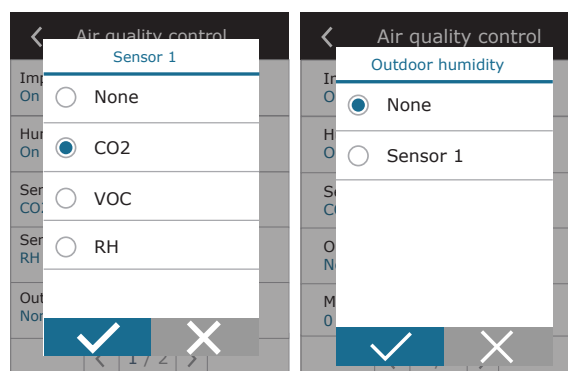

- **Minimum intensity** – select ventilation intensity at which the unit will operate when air quality (impurity or humidity) is good. If 0% is selected, the unit will stop when air impurity level is low.
- **Maximum intensity** – select ventilation intensity limit, under which the unit will operate when air quality (impurity or humidity) exceeds a defined value.
- **Check period** – specify how often the unit shall turn on to check air quality, when minimum intensity is set to 0%.

Fire damper¹ – parameters for the fire damper system tests can be set. It is possible to select either automatic or manual fire damper test. For automatic test, it is needed to set testing interval, as well as time of the day, when the tests will be performed. During fire damper test, AHU will be stopped for several minutes, fire dampers opened and closed. External fire damper controller will check are all the dampers functioning normally and will give the signal for AHU to restart or will indicate alarm message if something is wrong in the fire damper system.

Control sequence – here you can activate additionally connected duct-mounted heating or cooling devices (see “Installation Manual”) that will operate only when a heat exchanger or electrical heater alone cannot reach a desired temperature.

Numbers indicate the order of activation. All units have an integrated electrical heater, therefore it is factory-assigned as Stage 1. You can also assign an “external coil” (duct-mounted water heater/cooler) or an “external DX unit” (direct evaporation heat exchanger) as a stage. If an external coil is selected, you also must specify its type: “Hot water” (used for heating), “Cold water” (used for cooling). If additional heating/cooling devices are not available, you do not want to use them or an electrical heater, select “None”.

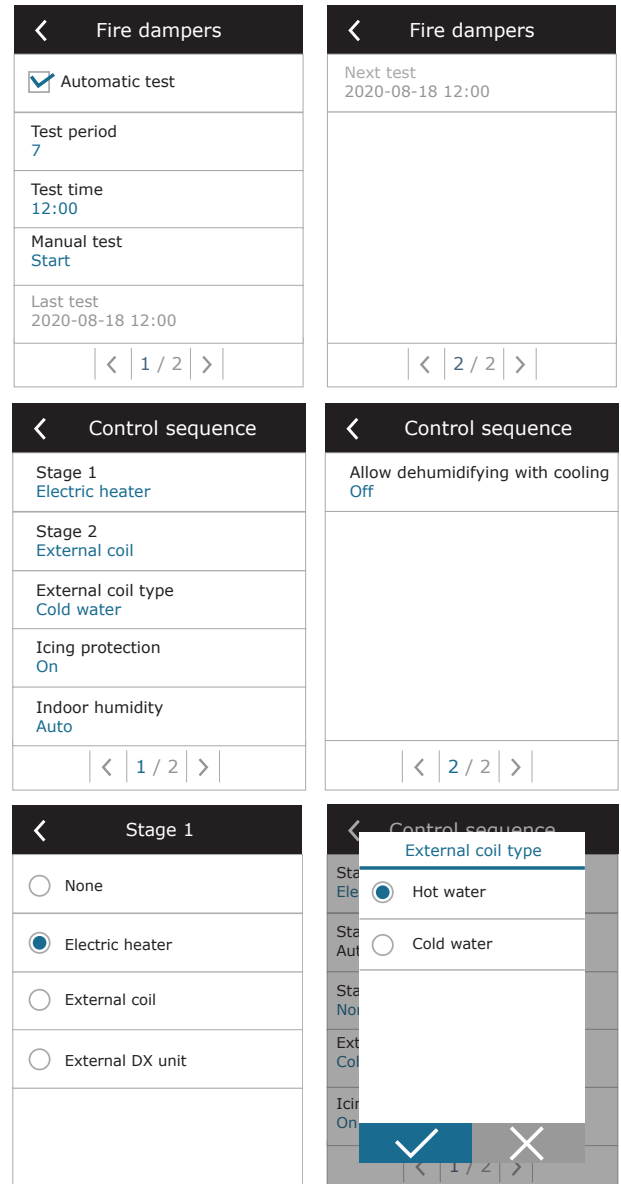

If you turn off an electric heater and do not activate a duct-mounted heater, the desired air temperature may not be reached when the outside air is cold.





¹ Available only if optional fire damper controller is configured and connected. Refer to Fire damper controller manual for more information.

- **Icing protection on CF units.** This function is intended to protect CF heat exchanger against freezing at low outdoor air temperatures and has the following settings:

Standard – the air-handling unit is stopped when outside air temperature drops below -4°C for longer than 1 hour.

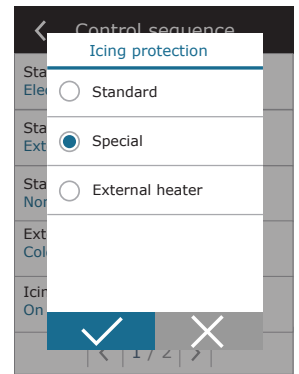
Special – heat exchanger is protected against freezing by changing the intensity of airflows, i. e. by supplying less cold outdoor air and extracting more warm indoor air, thus preventing frost formation. This function is sufficient to ensure frost protection for temperatures up to -10°C.







Special frost protection mode changes the balance of airflows, which may lead to pressure differences indoors, therefore, this mode is not recommended in airtight buildings (A+ or higher energy efficiency class) or in houses with a fireplace.



External heater – pre-heater, installed inside an outdoor air duct, upstream the air-handling unit, is switched on as soon as the heat exchanger freezing conditions occur. Efficiency of a heater depends on the outside air temperature, indoor humidity and actual flow of ventilated air. Integrated pre-heater operates only on demand to protect the heat exchanger against freezing. Under very low indoor humidity conditions, it is unlikely that the heat exchanger would freeze even at very low outdoor temperatures. To ensure proper operation of the pre-heater, a control panel or a separate humidity sensor must be installed in the ventilated premises (see “Installation Manual”).



When using the pre-heater, other duct mounted heating or cooling devices cannot be connected.



- **Icing protection on R units** – if there is high humidity in the exhaust air (for example in a newly built house), in winter condensate can start to accumulate inside the unit and eventually will freeze. The protective function will automatically reduce the ventilation intensity in winter, in cases when indoor humidity is too high and there is a risk of condensation on the internal walls of the unit. When the icing protection is active, the airflow reduction symbol will be displayed on the control panel (see section “Control panel C6.1”).

The icing protection function has the following settings:

On – automatic icing protection is activated by default and will reduce ventilation intensity if needed.

Off – icing protection will not work and user-defined airflow will be maintained.

- **Indoor humidity** – this setting is required to determine freezing conditions.

Possible settings:

Auto – indoor humidity is set automatically using an integrated in the control panel humidity sensor and/or external humidity sensor connected to B8 terminal of the controller (see “Installation Manual”).

10...90 % – setting a fixed indoor humidity value is possible when a control panel is installed in inappropriate location (or is not used) and no outside humidity sensors are connected.

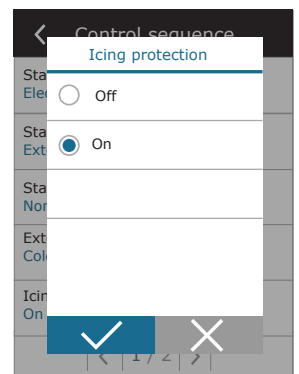



Wrong value of indoor humidity may cause antifreeze protection to malfunction.



- **Allow dehumidification with cooling** –this setting must be enabled to use a DX unit or duct-mounted water cooler to dehumidify the supply air. An option to enter a value for desired humidity will appear in the settings of standard ventilation modes (see Chapter 2.5.2).

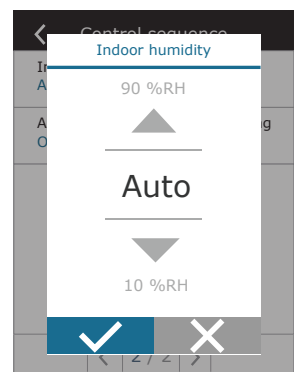

Connectivity – you can configure your PC network settings for remote use via web browser: IP address and subnet mask. You may also change other network parameters, if necessary: Gateway and BACnet ID. DHCP option automatically assigns a free IP address in the local network (do not use this option if you connect your computer directly to the unit).

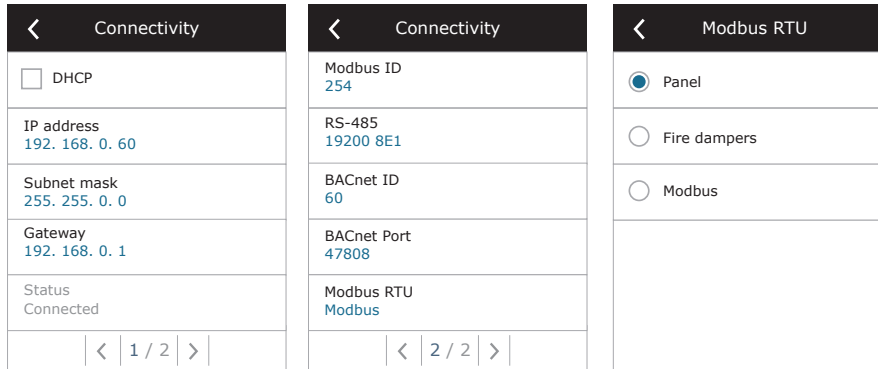

„Status“ line shows connection between AHU and internet:

- **Disconnected** – AHU is not connected to LAN or internet network.
- **No internet access** – AHU is connected to LAN network and communicates with router, but internet is not accessible.
- **Connected** – AHU has internet access.

In the „Modbus RTU“ line, it can be selected what device is connected to the terminals 1-2 of the C8 main board (See Domekt installation manual). Additional control panel for AHU, building BMS system or external fire damper controller can be used. If mentioned terminals on the board are not used, do not change this setting and leave it as “Panel”.

Panel sensor calibration – If the temperature and/or relative humidity measured by internal control panel sensors do not match the parameters measured by other devices, the accuracy of the sensors can be adjusted in this menu. The measured temperature may be adjusted within $\pm 5^{\circ}\text{C}$ and the humidity within $\pm 10\%$ range.

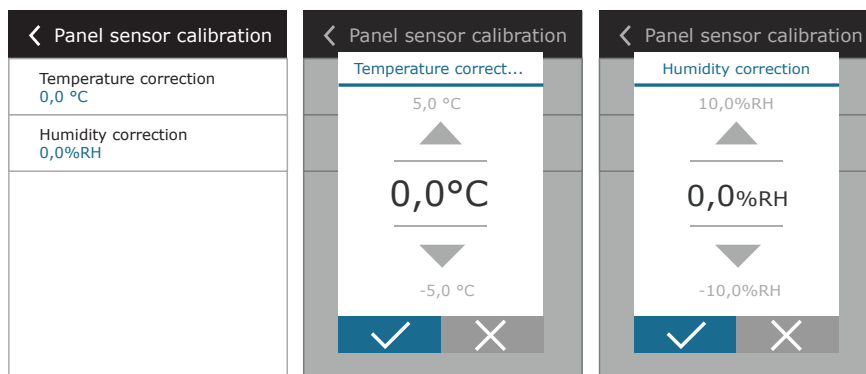

Clean filters calibration – after replacement, you must reset a filter timer by clicking this button.

Komfovent Control – here it is possible to reset user password, used for log-in to Komfovent Control app, that controls AHU via smartphone.

Reset settings – allows restoring factory settings.

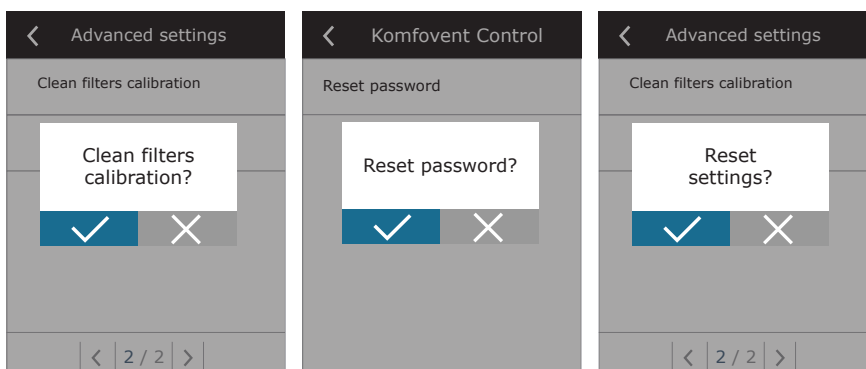

3.1.11. Alarms

Messages appearing during operation are indicated by a red warning symbol in the home screen. Device operation may be stopped given the severity of a fault message. To read a message, press OVERVIEW section in the menu. You can also delete current alarms or view a recorded history of faults (up to 50 recent messages).

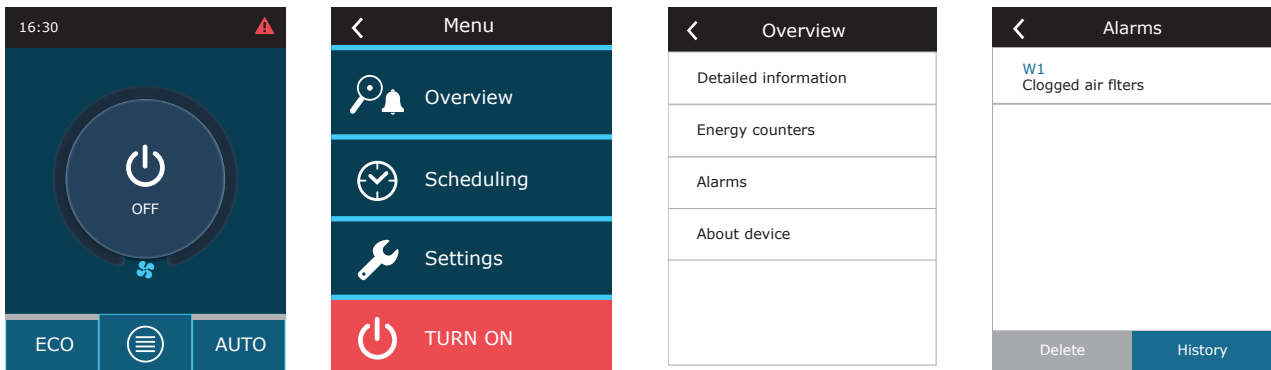

For more information and tips on alarms see Chapter "Troubleshooting".

3.1.12. About device

In the „Overview“ screen, menu „About device“ displays information about AHU type, firmware versions and serial number. By pressing C8 ID line, QR code will be generated, that can be used when connecting via Komfovent Control mobile app.

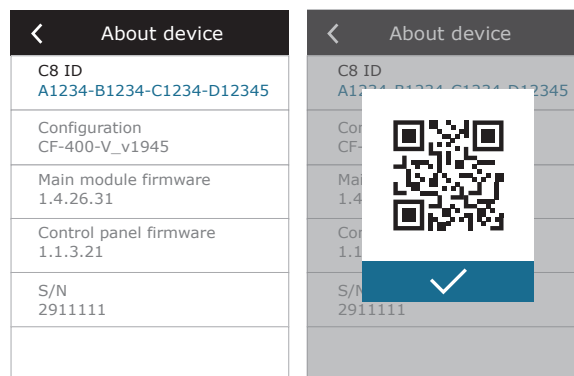

3.2. Control panel C6.2

Simple and user-friendly control panel for intuitive navigation and control of the unit. This control panel offers 4 standard operation modes (see Chapter 2.2) and switching ON/OFF with a touch of a button without any additional settings (settings are pre-set in the factory). This control panel is recommended for application when the user is not allowed to change any device settings or air temperature (for example, in the children's room). To change operating settings you will have to connect a C6.1 control panel, computer or smart phone to the unit.

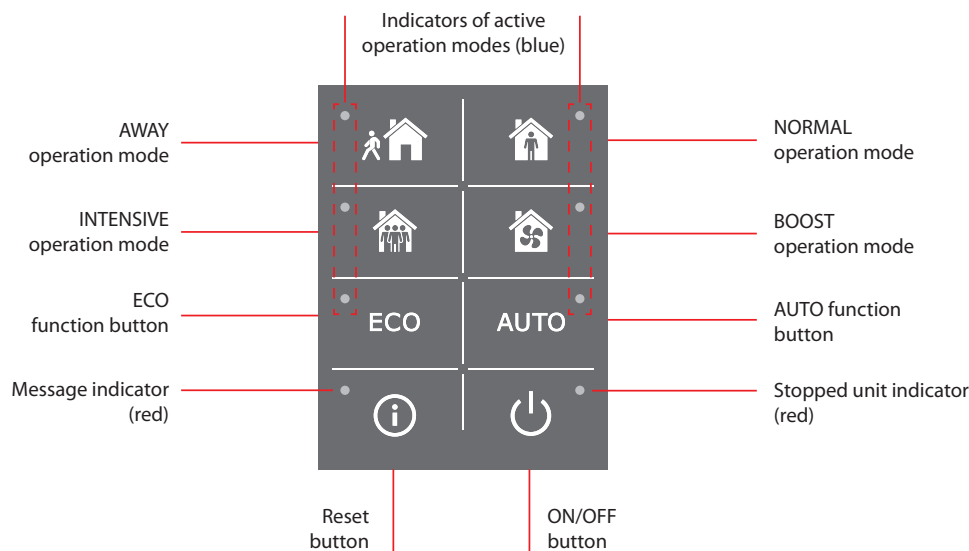

3.2.1. Turning on/off and changing operation modes

Red indication lamp lights up near the ON/OFF button if the unit is connected to the mains and currently is stopped.

To turn on/off the unit or to select an operation mode:

1. Press a button of a desired operation mode and the unit will start working.
2. A blue indicator light will turn on near the activated operation mode.
3. To turn off the device, press the ON/OFF button.
4. Once the unit is stopped, a red indicator light will turn on near the ON/OFF button.

3.2.2. Messages

In case of any fault messages during operation of the unit, a red indication lamp will light up near the reset button. Depending on the message type, the indicator may light up or blink (see Chapter "Troubleshooting"). To delete the message, press and hold the reset button for 5 seconds.

3.2.3. Control panel sounds

When a message appears, the control panel notifies the user with a beep. You may temporarily disable an audible alarm by pressing the reset button or deleting a fault message.

To disable audible alarms perform the following:

1. Press the ON/OFF button and hold for 5 seconds until you hear a beep and a red indicator light starts blinking.
2. If you hear a fault alarm and the reset button lights up in red, briefly press the reset button to turn off an audible alarm.
3. If the fault alarm is not audible and the reset indicator does not light up, briefly press the reset button to turn on an audible alarm.
4. To save your changes, press the ON/OFF button and hold it for 5 seconds until you hear a beep. Briefly press the ON/OFF button to return without saving.

3.2.4. Keypad lock

Control panel may be locked to protect against unauthorized access. Pressing the reset and ON/OFF buttons at the same time and holding for 5 seconds will inactivate the keypad. Perform the same procedure to unlock the keypad.

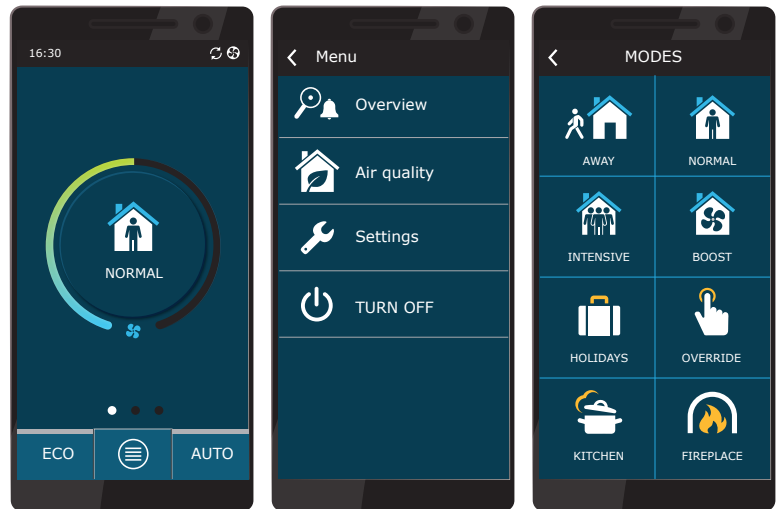

3.3. Control via smartphone

“Komfovent Control” app allows remote control of your air handling unit via mobile devices. Designed for connection to your home network, “Komfovent Control” – for connection via internet. Control of an air handling unit via your mobile device is almost the same as with a C6.1 control panel. Screens and settings are so similar that you can follow the chapter “C6.1 Control Panel” to perform necessary changes or settings. The app language is automatically selected according to the language used in your mobile device and can differ from the language of your air handling unit.



3.3.1. Connection to the air handling unit with a “Komfovent Control” app

Connect AHU to the network router with Internet access and check is DHCP activated in the control panel (see Advanced Settings → Connectivity) to assign a free IP address. Launch a “Komfovent Control” app in your smartphone (phone must have Internet access). When connecting for the first time, you will have to enter the device ID number or scan a QR code located on the front of the controller board (see “Installation Manual”) or on the AHU door. If the unit and smartphone are on the same local network, ID of the AHU is also possible to find using Wi-Fi.

 Language of the application is automatically selected according the language of the smartphone interface and may differ from that set by the user on the AHU. 

To add new unit press + symbol in the corner of the screen. Select „Scan QR code” for reading the QR code on the AHU door or control panel. Smartphone camera is activated. Then simply point the camera to the QR code and the unit ID will appear automatically. To connect with AHU that was previously saved on the list, check the line „Select from list”. Also ID can be found by scanning local WiFi network where AHU is connected, by selecting „Search in local network”.

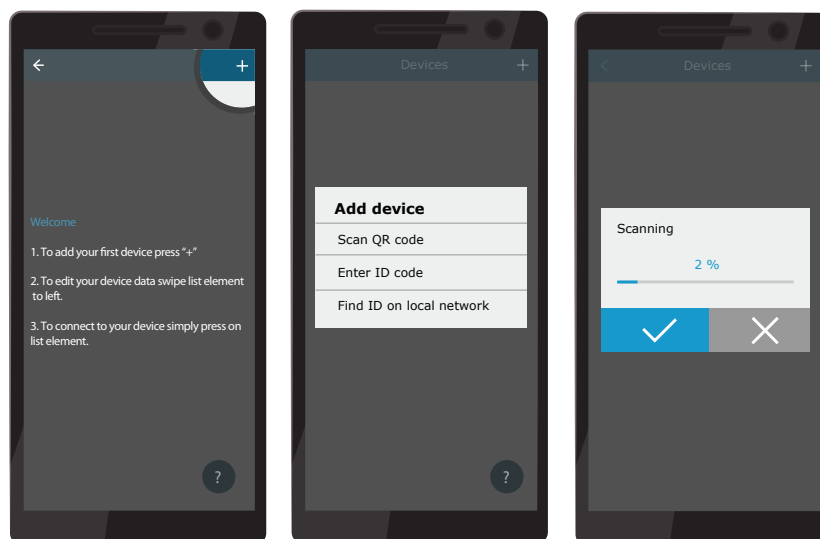

On the new device screen enter password **user**, accept and wait for connection with AHU. If app is used for the first time, You will be prompted to read and accept privacy policy (see Appendix No. 1). Also, when connected it is recommended to change the default password for additional safety reasons – app will display a reminder message each time you will be connecting with default password. If controlling several AHU's from the same smartphone, each of them will be saved on the list, thus simply tap near unit name on the list for connection. By sliding AHU name to the side, it is possible to edit connection settings or delete it from the list.

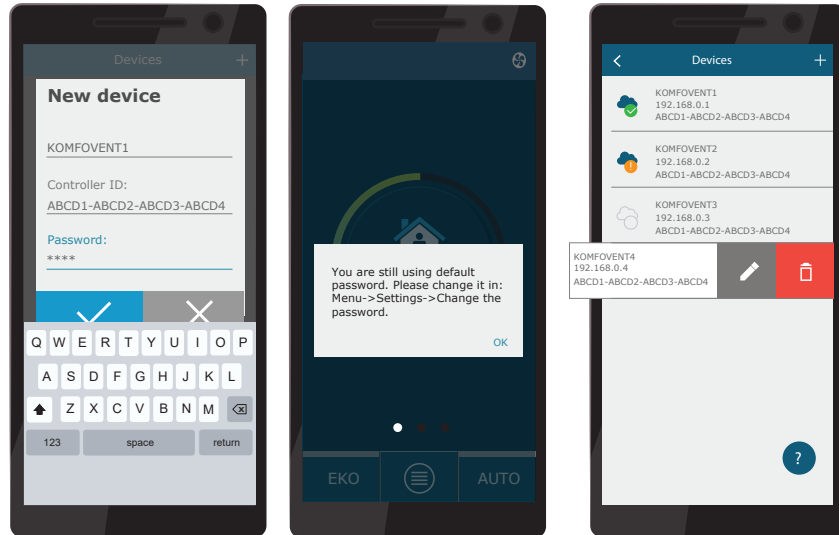

Most of "Komfovent Control" app and C6.1 control panel screens are very similar, so you can follow the chapter "C6.1 Control Panel" to perform necessary changes or settings.

Additionally in the "Komfovent Control" app you can change user password, synchronize system clock or review privacy policy if needed. All these options are available in the "Settings" screen.

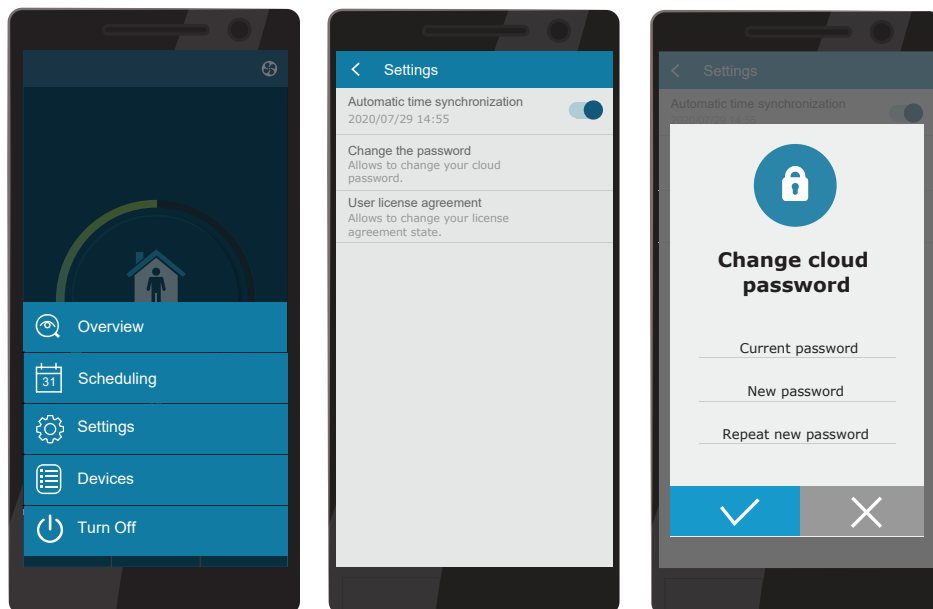

"Komfovent Control" app may not work, if router and/or firewall does not support UDP protocol.



If connection to the AHU fails, you will find more tips about app operation and answers to frequently asked questions by pressing "?" symbol on the screen.

3.4. Control via computer

The unit may be controlled via computer using a web browser. For information on connecting the unit to an internal network or directly to a computer, see the "Installation Manual".

Enter the device IP address in your web browser (IP address is displayed in the control panel) (see Advanced settings -> Connectivity):



Connect to the C8 control panel interface: enter the user name **user**, password **user¹** and press CONNECT.

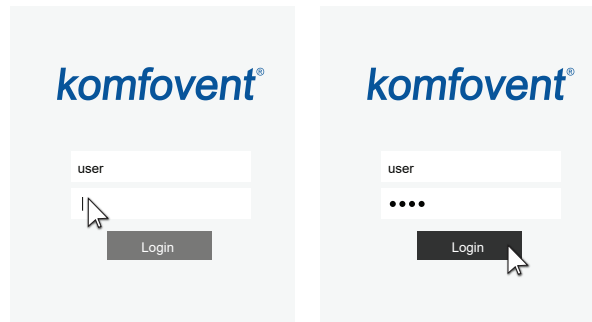

If the login was successful, you will be taken to the main window.

¹ Should you forget a changed password, it can be reset to the initial "user". To do this, you must restore the factory settings for the air handling unit using control panel.

CONTROL

OPERATION MODES

AWAY NORMAL **INTENSIVE** BOOST

KITCHEN FIREPLACE OVERRIDE HOLIDAYS

MODIFY >

OPERATION CONTROL

ECO AUTO

MODIFY >

OVERVIEW

| | | | |
|--|-----------------------------------|---|---------------------------------------|
| Supply temperature 20.2 °C 20.0 °C | Supply flow 50 % 50 % | Extract temperature 21.7 °C 21.0 °C | Extract flow 50 % 50 % |
| Ventilation level INTENSIVE | Relative humidity 46 % 50 % | Outdoor temperature 10.4 °C | Filter clogging 17 % 290x205x46 |

DETAILED >

OPERATION COUNTERS

| | | | |
|---|--|---|---|
| Supply fan 10 h Day Month Total | Exhaust fan 10 h Day Month Total | Air heater 10 h Day Month Total | Heat exchanger 10 h Day Month Total |
|---|--|---|---|

SCHEDULING

OPERATION PROGRAM

WORKING WEEK STAY AT HOME

OFFICE CUSTOM

SCHEDULE

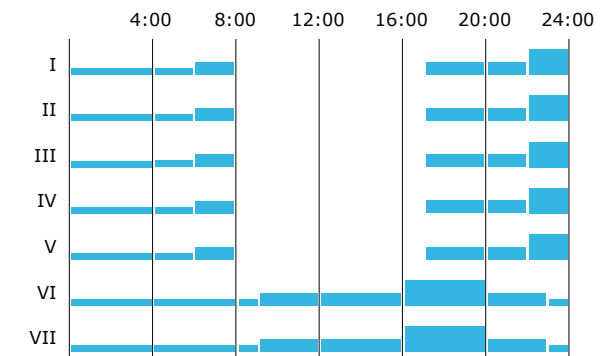

MODIFY >

3.4.1. Turning on/off and changing operation modes

Press any ventilation mode button to turn on the device. The unit starts operating and the button of the activated mode changes its colour. To stop the device, press the TURN OFF at the top of the main window:

CONTROL

OPERATION MODES



MODIFY >

OPERATION CONTROL



MODIFY >

If you select a special operation mode, you will need to select the duration of operation. ECO and AUTO modes are activated by pressing buttons on the right side of the window. Button of a selected mode will change its colour:

CONTROL

OPERATION MODES

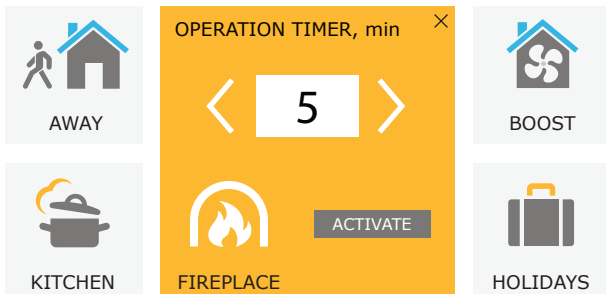

MODIFY >

OPERATION CONTROL



MODIFY >

3.4.2. Parameter overview

OVERVIEW section displays the following parameters: temperatures, air volumes and filter contamination. To see more, press "Detailed Information".

OVERVIEW

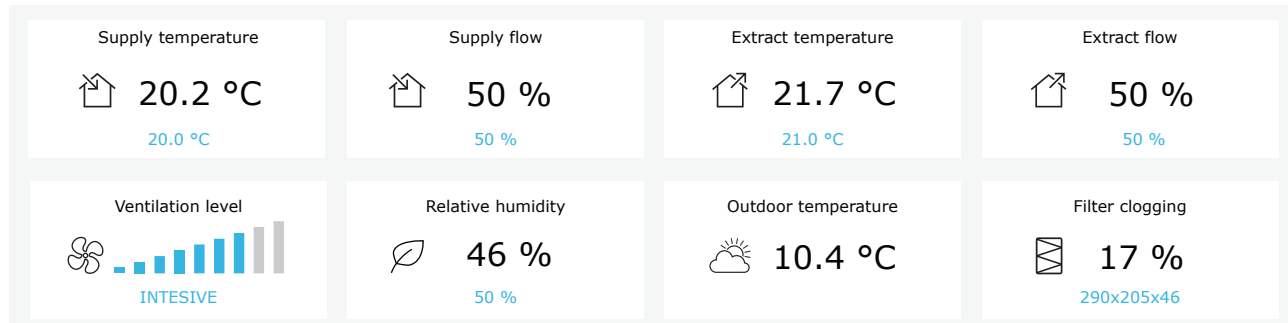

DETAILED >

In section OPERATING COUNTERS operating time of fans, heaters and heat exchanger are displayed. Daily, monthly, or total operation time is displayed by pressing buttons under a desired parameter.

OPERATION COUNTERS

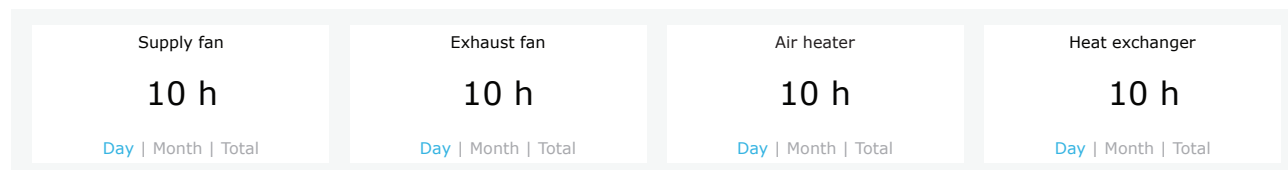









3.4.3. Air quantity and temperature settings

You can set air flow of supply and exhaust air, desired temperature and turn off/on an electric heater for each ventilation mode. If turned off, the heater will not turn on even when the desired temperature is not reached. If turned on, the heater will operate only when the heat exchanger alone cannot reach the set temperature. Press "Modify" to modify operation mode settings. After changing the settings, press "Save changes" button at the bottom of the window. Press the return symbol at the top to return to the main window.

◀
CONTROL

OPERATION MODES

| AWAY | NORMAL | INTENSIVE | BOOST |
|---|---|--|---|
|  |  |  |  |
| Supply flow, % <input style="width: 40px;" type="text" value="20"/> | Supply flow, % <input style="width: 40px;" type="text" value="50"/> | Supply flow, % <input style="width: 40px;" type="text" value="70"/> | Supply flow, % <input style="width: 40px;" type="text" value="100"/> |
| Extract flow, % <input style="width: 40px;" type="text" value="20"/> | Extract flow, % <input style="width: 40px;" type="text" value="50"/> | Extract flow, % <input style="width: 40px;" type="text" value="70"/> | Extract flow, % <input style="width: 40px;" type="text" value="100"/> |
| Temperature, °C <input style="width: 40px;" type="text" value="20.0"/> | Temperature, °C <input style="width: 40px;" type="text" value="20.0"/> | Temperature, °C <input style="width: 40px;" type="text" value="20.0"/> | Temperature, °C <input style="width: 40px;" type="text" value="20.0"/> |
| Electric heater <input checked="" type="checkbox"/> | Electric heater <input checked="" type="checkbox"/> | Electric heater <input checked="" type="checkbox"/> | Electric heater <input checked="" type="checkbox"/> |

| KITCHEN | FIREPLACE | OVERRIDE | HOLIDAYS |
|---|---|--|--|
|  |  |  |  |
| Supply flow, % <input style="width: 40px;" type="text" value="80"/> | Supply flow, % <input style="width: 40px;" type="text" value="60"/> | Supply flow, % <input style="width: 40px;" type="text" value="80"/> | Temperature, °C <input style="width: 40px;" type="text" value="20.0"/> |
| Extract flow, % <input style="width: 40px;" type="text" value="20"/> | Extract flow, % <input style="width: 40px;" type="text" value="50"/> | Extract flow, % <input style="width: 40px;" type="text" value="80"/> | Electric heater <input checked="" type="checkbox"/> |
| Temperature, °C <input style="width: 40px;" type="text" value="20.0"/> | Temperature, °C <input style="width: 40px;" type="text" value="20.0"/> | Temperature, °C <input style="width: 40px;" type="text" value="20.0"/> | Micro-ventilation <input style="width: 100px;" type="text" value="4 t. per day"/> |
| Electric heater <input checked="" type="checkbox"/> | Electric heater <input checked="" type="checkbox"/> | Electric heater <input checked="" type="checkbox"/> | Period <input style="width: 100px;" type="text" value="2018-12-24 / 2019-01-02"/> |
| | | Activate by contact <input style="width: 100px;" type="text" value="All time"/> | |
| | | Delayed start, min <input style="width: 40px;" type="text" value="0"/> | |
| | | Delayed stop, min <input style="width: 40px;" type="text" value="0"/> | |

SAVE CHANGES

RESTORE TO DEFAULT

3.4.4. ECO and AUTO mode settings

You can change the settings of these modes by pressing the “Modify” button below the ECO and AUTO buttons. More information on these function see in Chapters 2.4 and 2.5. After changing the settings, press “Save changes” button at the bottom of the window. Press the return symbol at the top to return to the main window.

<
CONTROL

OPERATION CONTROL



ECO



AUTO

Min. supply air temperature

Max. supply air temperature

Free cooling

Heater blocking

Cooler blocking

Air temperature

Air Impurity

Air humidity

Electric heater

SAVE CHANGES

RESTORE TO DEFAULT

3.4.5. Ventilation by a weekly schedule

To activate ventilation by a weekly schedule, press AUTO¹ and select a desired operation schedule in the SCHEDULING section. Button of the selected schedule will change its colour.

SCHEDULING

OPERATION PROGRAM

WORKING WEEK

STAY AT HOME

OFFICE

CUSTOM

SCHEDULE

| | 4:00 | 8:00 | 12:00 | 16:00 | 20:00 | 24:00 |
|-----|------|------|-------|-------|-------|-------|
| I | | | | | | |
| II | | | | | | |
| III | | | | | | |
| IV | | | | | | |
| V | | | | | | |
| VI | | | | | | |
| VII | | | | | | |

MODIFY >

¹ Ventilation by a weekly schedule is not possible when air quality control function is activated.

3.4.6. Creating a weekly schedule

You can modify a weekly schedule or create your own schedule by pressing the button “Modify” in the main window next to the section “Scheduling”. In the window that opens, you can choose from pre-programmed weekly programs or may as well create a new one. You may program 4 different days in each operation schedule and 5 different events for every day. Each day should be assigned a day of the week for which the program is valid. Start and end times as well as operation mode to be activated must be specified for each event. Selecting a standby mode is not necessary, as the unit will be stopped during the intervals for which no ventilation mode is assigned. To add an additional day, press “Add new”; to add an additional event - press +. Press “Save changes” button. Press the return symbol at the top to return to the main window.

<
SCHEDULING

OPERATION PROGRAM

WORKING WEEK

STAY AT HOME

OFFICE

CUSTOM

I
II
III
IV
V
VI
VII

×

AWAY ▾

00:00 - 06:00

NORMAL ▾

06:00 - 08:00

STANDBY ▾

08:00 - 17:00

NORMAL ▾

17:00 - 22:00

AWAY ▾

22:00 - 24:00

I
II
III
IV
V
VI
VII

×

AWAY ▾

00:00 - 09:00

NORMAL ▾

09:00 - 17:00

INTESIVE ▾

17:00 - 20:00

NORMAL ▾

20:00 - 23:00

AWAY ▾

23:00 - 24:00

I
II
III
IV
V
VI
VII

×

AWAY ▾

00:00 - 09:00

NORMAL ▾

09:00 - 22:00

AWAY ▾

22:00 - 24:00

+

ADD NEW

SAVE CHANGES

RESTORE TO DEFAULT

3.4.7. Alarms

In case of any fault messages during operation of the unit, a red exclamation mark will appear near the "Alarms" button. Device operation may be stopped given the severity of a fault message. Press the button ALARMS to read a message. You can also delete current messages or view a recorded history of faults (up to 50 recent messages). Press the return symbol at the top to return to the main window.

◀ ALARMS

ACTUAL ALARMS

W1: Clogged air filters

F3: Return water temperature low

RESET CURRENT ALARMS

ALARM HISTORY

19-12-2020 12:12:07 W1: Clogged air filters

18-12-2020 22:10:58 F3: Return water temperature low

3.4.8. Settings

Most of the settings are performed in the SETTINGS window. You can access this window by pressing SETTINGS button at the top of the window.

SETTINGS

USER INTERFACE

Language: English

AHU name: Komfovent

LOGIN PASSWORD

Enter new password: []

Confirm new password: []

DATE/TIME

Day - month - year: 24 08 2020

Time: 11 15

CONTROL MODE

Temperature control mode: Supply

CONNECTIVITY

Status: Connected

DHCP:

IP address: 192 168 0 60

Subnet mask: 255 255 255 0

Gateway: 192 168 0 1

BACnet ID: 60

BACnet Port: 47808

Modbus RTU: Panel

CONTROL SEQUENCE

Icing protection: Standard

Indoor humidity: --.% Auto

Stage 1: Electric heater

Stage 2: None

INFORMATION

Configuration: CF-400-V_v1945

Main module firmware: C8 1.3.18.21

Control panel firmware (1): C8 1.1.3.14

Control panel firmware (2): *.*.*

S/N: 291111

C8 ID: ANMP8-Nx4gXr-3OdgVn-GIA

C8 QR: Generate

Log: Download

Settings file: Save Load

AIR QUALITY

Impurity control:

Humidity control:

Sensor 1: CO2

Minimum intensity: 20 %

Maximum intensity: 70 %

Check period: 2 h

FILTERS

Clean filters calibration: Confirm

CLOUD

"Komfovent Control" password: Reset

SAVE CHANGES

RESTORE TO DEFAULT

After changing any settings, press SAVE CHANGES to apply new values.
 To discard changes, return to the start window by pressing the return button.
 Button RESTORE SETTINGS restores all settings to the factory defaults. Be careful not to press this button accidentally.

The following sections are displayed in the settings window:

USER INTERFACE – you can use it to change the menu language, flow measurement units as well as enter the device name:

- Selected **language** will be applied to a web browser and a control panel.
- **Device name** is displayed at the top of the web browser window. If one computer is used to control several air handling units, we recommend naming every device differently (for example, by room, address, etc.).

DATE/TIME – setting the time and date that are used for weekly operations schedules or other functions.

CONNECTIVITY – allows configuring the network, Modbus and BACnet settings.

“Status” line shows connection between AHU and internet:

- **Disconnected** – AHU is not connected to LAN or internet network.
- **No internet access** – AHU is connected to LAN network and communicates with router, but internet is not accessible.
- **Connected** – AHU has internet access.

In the „Modbus RTU“ line, it can be selected what device is connected to the terminals 1-2 of the C8 main board (See Domekt installation manual). Additional control panel for AHU, building BMS system or external fire damper controller can be used. If mentioned terminals on the board are not used, do not change this setting and leave it as “Panel”.

INFORMATION – overview of the controller and control panel firmware versions.

- By pressing “Generate” button, QR code will be generated, that can be used when connecting via Komfovent Control mobile app.
- For detailed performance analysis, you may download a **device logbook** which contains weekly operation data. To open a logbook, you will need a “Log plotter” app that you can download from the “Komfovent” website. This data may also help in the event of a failure and may facilitate repair procedures, therefore, we recommend downloading an operation logbook and handing it over to the authorised service personnel.
- **User-made device settings** may be saved in a settings file (for example, saving a weekly schedule or desired air volumes and temperature). This allows easy transfer of settings to another unit of the same type.

LOGIN PASSWORD – here you can change your password used for connecting to the unit via web browser. The default password is **user**, but it may be changed to any other password, having at least 4 characters.

CONTROL MODE – allows changing the temperature control modes (see Chapter 2.1).

- Select a **temperature control mode** from “Supply”, “Extract”, “Room” and “Balance” (see Chapter 2.1).

CONTROL SEQUENCE – here you can activate duct-mounted heating or cooling devices (see “Installation Manual”) and configure antifreeze protection of a plate heat exchanger.

- **Icing protection on CF units.** This function is intended to protect CF heat exchanger against freezing at low outdoor air temperatures and has the following settings:

Standard – the air-handling unit is stopped when outside air temperature drops below -4°C for longer than 1 hour.

Special – heat exchanger is protected against freezing by changing the intensity of airflows, i. e. by supplying less cold outdoor air and extracting more warm indoor air, thus preventing frost formation. This type of protection is sufficient for the temperatures up to -10°C.



Special frost protection mode changes the balance of airflows, which may lead to pressure differences indoors, therefore, this mode is not recommended in airtight buildings (A+ or higher energy efficiency class) or in houses with a fireplace.



External heater – pre-heater, installed inside an outdoor air duct, upstream the air-handling unit, is switched on as soon as the heat exchanger freezing conditions occur. Efficiency of a heater depends on the outside air temperature, indoor humidity and actual flow of ventilated air. Integrated pre-heater operates on demand to protect a heat exchanger against freezing. Under very low indoor humidity conditions, it is unlikely that the heat exchanger would freeze even at very low outdoor temperatures. To ensure proper operation of the pre-heater, a control panel or a separate humidity sensor must be installed in the ventilated premises (see “Installation Manual”).



When using the pre-heater, other duct mounted heating or cooling devices cannot be connected.



Icing protection on R units – if there is high humidity in the exhaust air (for example in a newly built house), in winter condensate can start to accumulate inside the unit and eventually will freeze. The protective function will automatically reduce the ventilation intensity in winter, in cases when indoor humidity is too high and there is a risk of condensation on the internal walls of the unit. When the icing protection is active, the airflow reduction symbol will be displayed on the control panel (see section “Control panel C6.1”).

The icing protection function has the following settings:

On – automatic icing protection is activated by default and will reduce ventilation intensity if needed.

Off – icing protection will not work and user-defined airflow will be maintained.

- **Indoor humidity** – this setting is required to determine freezing conditions. When “Auto” setting is selected, indoor humidity will be set automatically using an integrated humidity sensor and/or external humidity sensor connected to B8 terminal of the controller (see “Installation Manual”). If the control panel is installed in an inappropriate location (or is not used) and no outside humidity sensors are connected, uncheck the AUTO box and enter the indoor humidity in the range of 10...90 %.



Wrong value of indoor humidity may cause antifreeze protection to malfunction.



- **Stage numbers indicates the order of activation of heating/cooling devices.** All units have an integrated electrical heater, therefore it is factory-assigned as Stage 1. You can also assign an “external coil” (duct-mounted water heater/cooler) or an “external DX device” (direct evaporation unit) as a stage. If an external coil is selected, you also must specify its type: “Hot water” (used for heating), “Cold water” (used for cooling). If additional heating/cooling devices are not available, you do not want to use them or an electric heater, select “None”.



If you turn an electric heater off and do not use a duct-mounted heater, the desired air temperature may not be reached when the outside air is cold.



- **Allow dehumidification with cooling** – this setting must be enabled to use a DX unit or duct-mounted water cooler to dehumidify the supply air. An option to enter a value for desired humidity will appear in the settings of standard ventilation modes (see Chapter 2.5.2).

AIR QUALITY – here you can activate and set-up air quality control which will be used in AUTO mode (see Chapter 2.5.2):

- **Impurity control** – turning on/off an impurity control function. At least one CO₂ or VOC sensor must be connected to the controller board to activate this function (see Chapter 2.5.2.). If ventilation by a weekly schedule is required, this function must be turned off.
- **Humidity control** – turning on/off a humidity control function. Humidity control function requires a humidity sensor. If no humidity sensor is connected to the controller board, sensor integrated in a control panel will be used for this purpose (see Chapter 2.5.2.).
- **Sensor 1** – specify the type of the sensor connected to a terminal B8 (see “Installation Manual”). If this sensor is not available, select “None”.
- **Outside humidity** – this option appears only if one of the sensors is of RH type (humidity sensor). If any of the connected sensors are installed in the outdoor air flow, specify which one. If none of the installed humidity sensors measure the outside humidity, select “None”.
- **Minimum intensity** – select ventilation intensity at which the unit will operate when air quality (impurity or humidity) is good. If 0% is selected, the unit will stop when air impurity level is low.
- **Maximum intensity** – select ventilation intensity limit, under which the unit will operate when air quality (impurity or humidity) exceeds a defined value.
- **Check period** – specify how often the unit shall turn on to check air quality, when minimum intensity is set to 0%.

Fire damper¹ – parameters for the fire damper system tests can be set. It is possible to select either automatic or manual fire damper test. For automatic test, it is needed to set testing interval, as well as time of the day, when the tests will be performed. During fire damper test, AHU will be stopped for several minutes, fire dampers opened and closed. External fire damper controller will check are all the dampers functioning normally and will give the signal for AHU to restart or will indicate alarm message if something is wrong in the fire damper system.

| FIRE DAMPERS | |
|----------------|---|
| Automatic test | <input checked="" type="checkbox"/> |
| Test period | <input type="text" value="7"/> |
| Test time | <input type="text" value="12"/> <input type="text" value="00"/> |
| Manual test | <input type="button" value="Start"/> |
| Last test | <input type="text" value="-"/> |
| Next test | <input type="text" value="-"/> |

FILTERS – once filters are replaced, calibrate new filters and confirm replacement in the unit.

CLOUD – Here it is possible to reset user password, used for log-in to Komfovent Control app, that controls AHU via smartphone.

4. TROUBLESHOOTING

Device automation continuously monitors the operation of various components and function algorithms. If something goes wrong, the device informs you with a message and an audible alarm from a control panel (alarm may be disabled). Messages are divided into critical alarms and notifications. Critical alarms occur when the device cannot continue operation without intervention of the user or an authorised service representative. Notifications are used to warn the user about possible faults or small discrepancies but they do not stop the device.

In case of a message, perform the following actions:

- Read the message and note its number displayed on screen (control panel, computer, smartphone).
- Stop the unit. If heating/cooling devices were running at that time, pressing the OFF button will keep the unit running for a few minutes until heater/cooler temperature is stabilized.
- Once the unit stops, unplug it from the mains.
- Find tips in the “Message Table” by the message number (see Chapter 4.1).
- If possible, eliminate the cause. If a fault cannot be resolved, contact an authorized service representative.
- After troubleshooting, make sure no foreign objects, debris or tools are left inside the unit, and only then close the unit door.
- Connect the unit to the mains and delete all alarms from the message window.
- If a fault is not resolved, depending on its nature, the device may not start or may start and display an alarm after a while.



- Before performing any work inside the unit, make sure that the device is stopped and unplugged.
- After stopping the unit, wait a few minutes for the fans to stop rotating and the heating devices to cool down before opening the door.



¹ Available only if optional fire damper controller is configured and connected. Refer to Fire damper controller manual for more information.

4.1. Table of messages

Below is a list of messages and recommended actions to resolve faults. These messages are displayed in the C6.1 control panel, mobile app or a computer. F stands for critical alarms, W – for notifications.

| Code | Message | Possible cause | User's actions |
|---------|------------------------------|--|--|
| F3 | Return water temperature low | <ol style="list-style-type: none"> 1. No hot water in the water heater system. 2. Circulation pump not working. 3. Water control valve or actuator not working. 4. Return water temperature sensor is faulty or installed incorrectly. | <ol style="list-style-type: none"> 1. Check if hot water is in the system. 2. Check if a circulation pump is working. 3. Check if a water control valve is opening. 4. Check whether a return water sensor is installed according to the directions specified in "Installation Manual". Contact your installer or authorized service. |
| F4 | Low supply air temperature | <ol style="list-style-type: none"> 1. Integrated heaters not working. 2. Additional heating/cooling devices faulty or installed incorrectly. 3. Faulty air temperature sensor. | <ol style="list-style-type: none"> 1. Contact authorised service. 2. Contact the company that installed or sold additional heating/cooling equipment. 3. Contact authorised service. |
| F5 | High supply air temperature | <ol style="list-style-type: none"> 1. Integrated heaters malfunctioning. 2. Additional heating/cooling devices malfunctioning or installed incorrectly. 3. Faulty air temperature sensor. | <ol style="list-style-type: none"> 1. Contact authorised service. 2. Contact the company that installed or sold additional heating/cooling equipment. 3. Contact authorised service. |
| F7 | Heat exchanger failure | <ol style="list-style-type: none"> 1. Rotor heat exchanger not rotating (only for DOMEKT R devices). 2. Air bypass damper of the counter-flow heat exchanger malfunctioning (only for DOMEKT CF units). | <ol style="list-style-type: none"> 1. Check for foreign objects or debris preventing rotation of the rotor drum. Check if the rotor belt is not torn. 2. Contact authorised service. |
| F8 | Heat exchanger icing | <ol style="list-style-type: none"> 1. Antifreeze protection of the heat exchanger is malfunctioning. 2. Antifreeze protection is switched off and outside air temperature is below -4 °C.¹ | <ol style="list-style-type: none"> 1. Check the antifreeze protection settings. Check if an external pre-heater is working, if used. 2. Check antifreeze protection settings. If an integrated or external pre-heater is not used, you will not be able to use a device with a counter-flow heat exchanger when the outside temperature drops below -4 °C. |
| F9 | Internal fire alarm | <ol style="list-style-type: none"> 1. Internal air temperature is above 50°C 2. Faulty temperature sensor. | <ol style="list-style-type: none"> 1. Locate the heat source in the ductwork or unit. 2. Contact authorised service. |
| F10 | External fire alarm | A fire alarm was received from the building fire system. | Once fire alarm is removed, the unit must be started using a control panel, computer or a smartphone. |
| F11-F22 | Temperature sensor failure | Temperature sensor(s) faulty or not connected. | Contact authorised service. |
| F23-F26 | Controller failure | Controller main board malfunction. | Contact authorised service. |
| F28 | Temperature sensor failure | No signal from temperature sensor located in the control panel. | Check control panel wiring and cables. Replace the control panel, if necessary. |
| F29 | Humidity sensor failure | No signal from humidity sensor located in the control panel. | Check control panel wiring and cables. Replace the control panel, if necessary. |
| F30 | Humidity sensor failure | Faulty or disconnected air humidity sensor by which the unit is operating. | Check the sensor wiring, replace the sensor or indicate that this sensor is not used in the settings. |
| F31 | Impurity sensor failure | Faulty or disconnected impurity sensor by which the unit is operating. | Check the sensor wiring, replace the sensor or indicate that this sensor is not used in the settings. |
| F32-F37 | Heat exchanger failure | Rotor heat exchanger not rotating (only for DOMEKT R devices). | <ol style="list-style-type: none"> 1a. Check for foreign objects or debris preventing rotation of the rotor drum. Check if the rotor belt is not torn. 1b. Contact authorised service. |
| F38-39 | Air flow sensor failure | Disconnected or faulty air flow sensor(s) | It is necessary to check the sensor connections or to change the sensor. |
| F40 | Communication error | <ol style="list-style-type: none"> 1. Wrong settings 2. Not connected or broken external fire damper controller. | <ol style="list-style-type: none"> 1. If fire damper system controller is not used with AHU, disable it in the Settings->Connectivity->Modbus RTU 2. Contact person responsible for fire damper system maintenance or authorized service. |
| F42-F45 | Fire damper failure | Incorrect operation of one or more fire damper actuators | Contact person responsible for fire damper system maintenance or authorized service. |

¹ Only in CF units.

| Code | Message | Possible cause | User's actions |
|---------|-------------------------------|---|---|
| F46-F50 | External fire alarm | External fire alarm received from fire damper controller. | Fire alarm can be generated from building fire system, from smoke detectors, thermostats of the damper actuator or etc. |
| F51 | Electric heater overheat | 1. Integrated heaters malfunctioning. 2. Faulty air temperature sensor. | Contact authorised service. |
| W1 | Clogged air filters | Replacement of air filters is necessary. | Switch off the device and replace air filters. Delete the message after replacement. |
| W2 | Service mode | Temporary special operating mode that can only be activated by a service specialist. | If the unit has been recently repaired, contact the person who repaired the unit to determine if service mode can be disabled. Service mode is turned off by deleting the message. |
| W3 | Return water temperature low | Warning that the water temperature is lower than that required to heat the supply air. | Check the condition of a circulation pump and the heating system as well as operation of a heating damper actuator. |
| W4 | Humidity sensor failure | One of the two humidity sensors is faulty or not connected. Device is operating by another connected sensor. | Check the control panel wiring, replace the sensor or select that this sensor is not used in the settings. |
| W5 | Impurity sensor failure | One of the two air quality sensors is faulty or not connected. Device is operating by another connected sensor. | Check the control panel wiring, replace the sensor or select that this sensor is not used in the settings. |
| W6 | Low heat exchanger efficiency | 1. Message may appear when air is extracted through an additional branch, and, as a result, the heat exchanger efficiency has decreased (only for DOMEKT R devices). 2. Supply air volume significantly exceeds the extract air volume. 3. The unit door is not fully closed and different air flows are mixed. | 1. If additional extraction is not used, the fifth branch must be closed. Check if an air closing damper installed in the auxiliary extraction duct is completely closed. 2. If such air flow difference is not required, unify air flow settings. 3. Check that the unit door is pressed firmly and that gaskets are not worn. |

4.2. Table of light indicators of the C6.2 control panel

Since the C6.2 control panel does not have a display, it notifies about operation or malfunctions by means of indicator LEDs. Layout and description of indication LEDs is presented in Chapter 3.2. Different blinking and colour indicates different messages.

| Indication | Operation | Possible cause | User's actions |
|--|--------------------|--|--|
| Indicator near ON/OFF button lights up in red. | Device not working | Device stopped. | Press ON/OFF button to turn on/off the device. |
| Blue indicator near one of ventilation mode buttons is blinking | Device not working | The unit will soon start in a ventilation mode the indicator of which is blinking. | No actions required. |
| Blue indicator light next to AUTO button lights up | Device not working | The device is stopped according to a weekly schedule or because of the air quality function. | If you want the unit to operate continuously, not by a schedule or air quality, press AUTO button. |
| Blue indicator near one of ventilation mode buttons lights up | Device is working | The unit operates in a ventilation mode the indicator of which is on. | No actions required. |
| Red indicator for messages and blue indicator for ventilation mode light up. | Device is working | Contaminated air filters or other notifications are present. | To read the exact notification, connect a computer or a smartphone to the unit. Follow the table of messages in Chapter 4.1. |
| Red indicator for messages and blue indicator for ventilation mode are blinking. | Device is working | Temporary special operating mode that can only be activated by a service specialist. | If the unit has been recently repaired, contact the person who repaired the unit to determine if service mode can be disabled. Service mode is turned off by deleting a message. |
| Red message indicator is blinking | Device not working | Critical fault messages are present that prevent the unit from working. | To read the exact critical fault message, connect a computer or a smartphone to the unit. Follow the table of messages in Chapter 4.1. |
| All panel indicators are blinking | Not important | Cable between the device and the panel is damaged or connected incorrectly. | Check the control panel wiring following the "Installation Manual" or contact your installer or authorised service representative. |
| Keypad buttons are inactive | Not important | 1. Panel lock activated (see Chapter 3.2.4). 2. Faulty panel. | 1. To unlock the control panel, press ON/OFF button and the reset button at the same time and hold for 5 seconds. 2. Contact authorised service. |

5. PERIODICAL MAINTENANCE

For proper operation of the air handling unit, it should be periodically inspected, the air filters replaced in due time and the interior of the unit cleaned. Some of the maintenance works can be performed by the user and others only by a qualified specialist.



The operation, maintenance or repair of the air handling unit is prohibited for people (including children) with mental, physical or sensory disabilities, as well as for persons without sufficient experience and knowledge, unless supervised and instructed by the person responsible for their safety in accordance with these instructions.



- Before performing any work inside the unit, make sure that the device is stopped and unplugged.
- After stopping the unit, wait a few minutes for the fans to stop rotating and heating devices to cool down before opening the door.
- Open the door of flat ceiling mounted devices carefully, do not let them swing freely on the hinges. Also, be careful, as the filters may fall out when the door is opened.



The following table provides recommended regular maintenance intervals for the unit. Actual frequency of maintenance works depends on operating conditions, amount of dust and impurities in the ventilated air as well as environment in which the unit is installed. Locations of all the mentioned device components and notes indicated in the "Installation Manual".

| Task | Frequency | Performed by |
|---|--------------|------------------------|
| Check filters; change, if necessary | 3 months | User |
| Change filters | 6 months | User |
| Clean dust inside the unit | 6 months | User |
| Check the rotor belt for wear and tension (only for DOMEKT R devices) | 12 months | User |
| Replacement of a worn rotor belt | If necessary | Service representative |
| Check the rotor wheel brushes for tightness and wear (only for DOMEKT R devices) | 12 months | Service representative |
| Replace worn rotor wheel brushes | If necessary | Service representative |
| Check the rotor wheel for contamination with dust/other materials (only for DOMEKT R devices) | 6 months | User |
| Clean the rotor wheel | If necessary | Service representative |
| Check the plate heat exchanger for contamination with dust/other materials (only for DOMEKT CF devices) | 6 months | User |
| Clean the plate heat exchanger | If necessary | Service representative |
| Check if the rotor wheel rotates freely and at the required speed (only for DOMEKT R devices) | 12 months | Service representative |
| Check operation of an air bypass damper of the plate heat exchanger (only for DOMEKT CF units) | 12 months | Service representative |
| Check if dampers open/close fully (if available) | 6 months | User |
| Rotate fans by hand to check for any obstructions, extraneous noise and vibrations | 12 months | User |
| Check fan operation and clean impellers | 12 months | Service representative |
| Check operation of heating/cooling devices | 12 months | Service representative |
| Check automation and safety devices | 12 months | Service representative |
| Check tightness of the doors and state of gaskets | 12 months | Service representative |
| Clean piping and siphon of the condensate drainage (only for DOMEKT CF units) | 12 months | User |

The inside of the air handling unit can be cleaned with a vacuum cleaner and/or a damp cloth. When cleaning, prevent water from entering electrical components of the unit. Make sure all surfaces are completely dry before starting the unit.

5.1. Filter inspection and replacement

Check if filters are not damaged, torn or dampened. Filter replacement time depends on environmental contamination, season of the year, for example, during spring and summer filters may be contaminated with pollen, fluff or insects, therefore change intervals are shorter. Replace filters if they are visibly dirty even though it is not time yet. When replacing filters earlier, be sure to perform a clean filter calibration as described in Chapter 3. When filters are replaced upon a filter replacement message, calibration is not required. Contaminated filters increase pressure loss of the unit, reduce purification efficiency and increase power consumption.

The pictures below show the location of filters on different models of devices. Because the devices are manufactured with the right and left access sides, and the images show only one access side, your device may look different from the one shown. Layout of filters and components presented in the "Installation Manual".

Domekt R 150 F

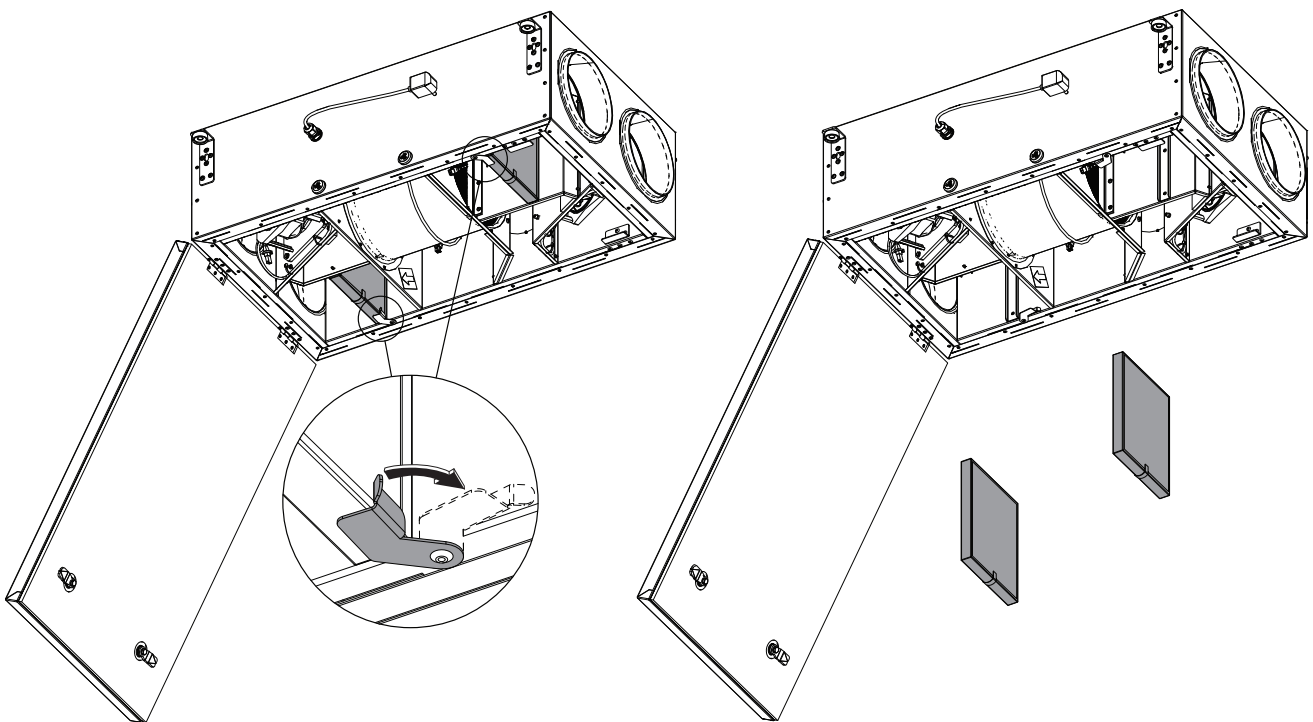

Domekt R 300 V

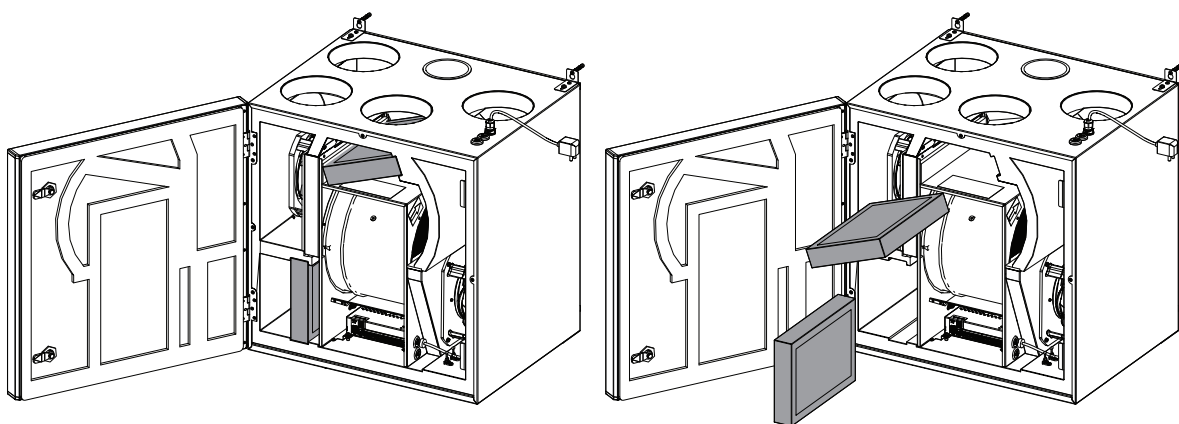

Domekt R 300 F

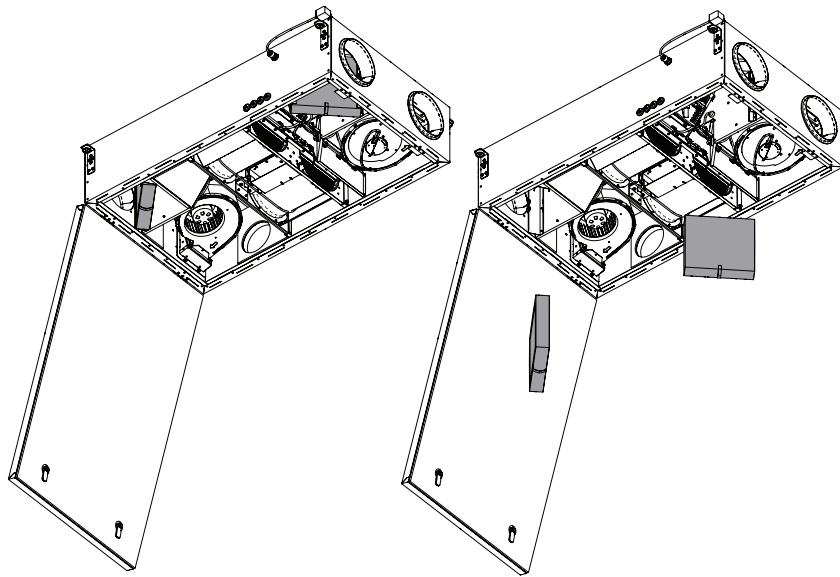

Domekt CF 200 F

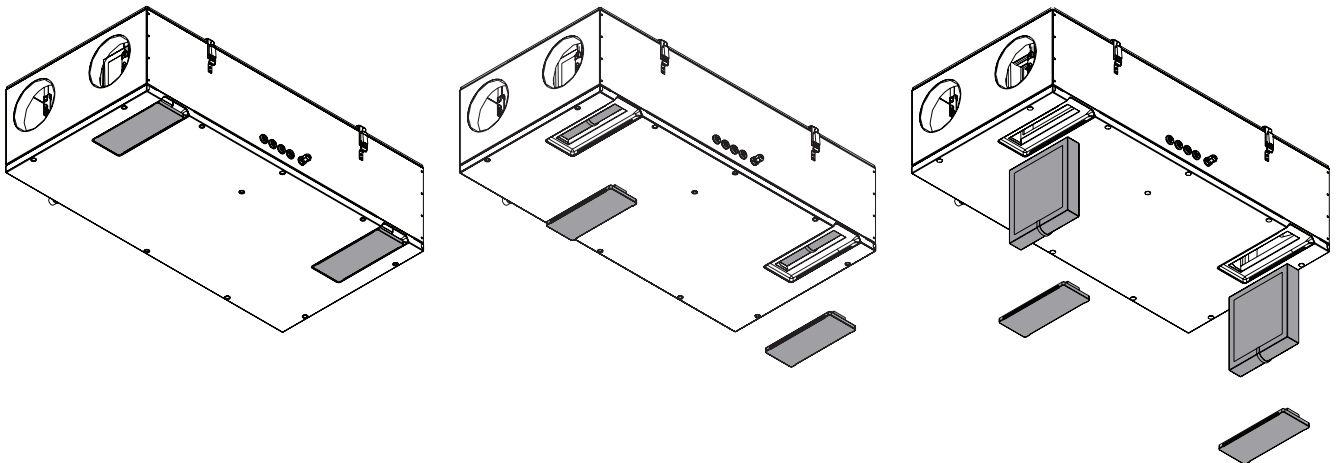

KOMFOVENT CONTROL Terms of Use and Privacy Notice

1. Introduction

These Terms of Use (“the Terms”) govern the use of the KOMFOVENT CONTROL mobile application, operated by KOMFOVENT, UAB (“KOMFOVENT”), and the use of other related services. KOMFOVENT CONTROL is a mobile application designed to CONTROLly monitor and control a KOMFOVENT air handling unit connected to the Internet. These Terms also contain information about personal data processed for the above-mentioned purposes.

You must confirm that you have read the Terms of Use to use the KOMFOVENT CONTROL application. Please read all the Terms carefully and start using the KOMFOVENT CONTROL application only if the terms are clear and acceptable. KOMFOVENT reserves the right, at its sole discretion, to change these Terms of Use. If you continue to use KOMFOVENT CONTROL after we post changes to the Terms of Use, you are signifying your acceptance of the new terms.

2. Functionality

KOMFOVENT CONTROL allows monitoring and controlling your KOMFOVENT air handling unit remotely. As a user, you can see existing errors or warning messages, select and adjust the AHU settings and main parameters that provide information about the operation of the unit and facilitates its control.

The user can turn the device on/off, change modes and settings (airflow, temperatures, etc., depending on the device configuration), set a weekly schedule or air quality control function. User can monitor: sensor readings (temperature, humidity, etc., depending on installed sensors), flow/fan intensity information, heat exchanger operation and efficiency, filter contamination, power consumption, messages, message history, etc. KOMFOVENT may also perform software updates remotely (regarding bug fixes, compatibility of the application/controllers/server, support of new functions, etc.).

Detailed information on the KOMFOVENT CONTROL functions and operation can be found in the DOMEKT User Manual available at www.komfovent.com.

In case of any discrepancies between the product information provided in the Terms of Use and the User Manual, the information specified in the User Manual shall prevail.

3. Your Responsibility

Device ID number (ID) and a password identify you as a user in the KOMFOVENT CONTROL application. We strongly recommend that you make use of a unique and strong password that is reasonably hard to guess or find out (for example, do not use your name, birth date, car make or the same password used in other accounts) and do not disclose it to others. If you suspect someone is using your password, change it immediately.

The use of the KOMFOVENT CONTROL application is free except for any possible data usage fees that may be set by your Internet service provider.

4. Rights

Copyrights, other rights and contents of KOMFOVENT CONTROL are owned by KOMFOVENT and protected by law.

Commercial use of these rights without a prior written consent of KOMFOVENT is prohibited. This also applies to copying, transferring and sale of information, images, graphics, program codes and technical solutions. Bypassing security measures or system is prohibited.

Unauthorized use or distribution of the KOMFOVENT CONTROL application may violate copyrights, trademark and/or other laws and may be subject to civil and criminal liability.

5. Privacy Notice

5.1. Installation

In order to install the KOMFOVENT CONTROL application, you must agree with the Terms of Use and connect your controller to the Internet. Once the controller is connected to the Internet, the following data is periodically sent to the KOMFOVENT server:

- Product/controller ID number (ID).
- Software versions.
- Device configuration name.
- Product serial number.
- IP address and port number of the controller.
- Date of the first attempted login.

The processing of this data is necessary for the operation of the KOMFOVENT CONTROL app and provision of remote control services. If you use the KOMFOVENT

CONTROL application, the legal basis for the processing of such data is the execution of the agreement on the use of the KOMFOVENT CONTROL mobile application.

The above-mentioned data is periodically sent to the KOMFOVENT server even if you do not start using your KOMFOVENT CONTROL application or decide to stop using KOMFOVENT CONTROL after connecting your device to the Internet. In this case, the legal basis for the processing of such data is your consent expressed by connecting your controller to the Internet. To stop sending the above-mentioned data, disconnect your controller from the Internet.

5.2. Login

To start controlling and monitoring your device via the KOMFOVENT CONTROL application, simply enter your device ID/scan the QR code and enter your password in the application. The controller and mobile phone must have access to the Internet.

5.3. Data Categories and Objectives

The following is an overview of data and personal information processed by KOMFOVENT:

Account credentials:

- User password.

Information about the product and its use:

- Date of the controller's first attempt to connect to the server.
- Product/controller ID number (ID).
- Product serial number.
- Software versions.
- Device configuration name.
- Data and parameters for control and operation of the product/device:
 - Operation modes and settings: flow, temperature, humidity and air quality settings, disabling or enabling of individual units.
 - Values for different types of device sensors, for example, temperature sensors, humidity sensors, etc.
 - Calibration values, operation limits.
 - Informative parameters: fan control levels, efficiency, energy consumption meters, notifications.
 - Parameters affecting device performance.
 - Weekly schedule times, programs, modes.
 - Settings of time, measurement units.

KOMFOVENT processes personal data for the following purposes:

- To provide a remote control feature to the user;
- To provide remote assistance;
- To analyse product operation;
- To improve the product and the KOMFOVENT CONTROL operation;

- To handle complaints and warranty requests.

The legal basis for the processing of such data is the execution of the agreement on the use of the KOMFOVENT CONTROL mobile application.

5.4. Storage and Deletion

Data specified in point 5.1 Installation is periodically sent to the KOMFOVENT server. The server does not connect to the controller and does not store any more data until the KOMFOVENT CONTROL application is downloaded and the Terms of Use are accepted. Once the Terms of Use are accepted, the server starts periodically collecting the data specified in point 5.3 Data Categories and Objectives.

Device data history is stored for 1 month.

After that, the data is safely and carefully deleted unless it is anonymized or there are other reasons and legal basis for extended storage.

5.5. Transfer of Personal Data

Personal data processed by KOMFOVENT shall not be transferred to third parties for management purposes. Personal data may only be transferred to data processors providing installation, maintenance and other services to KOMFOVENT. These companies process data on our behalf and under signed data processor contracts.

Your data will not be transferred to others unless you have given your consent or KOMFOVENT has a legal obligation to transfer such data or the transferred data is anonymized.

5.6. Additional Information

You have the right to access your personal data, to have it corrected or deleted, to restrict the processing and portability of your data, to refuse the processing of your personal data and the right to complain to the State Data Protection Inspectorate. Requests for enforcement of your rights shall be sent to the specified e-mail address or to the KOMFOVENT, UAB office address.

6. Notification and Termination

You may stop using the KOMFOVENT CONTROL app and/or stop periodical collection of your device information specified in point 5.3 Data Categories and Objectives at any time. This can be done in the KOMFOVENT CONTROL application by refusing to accept the Privacy Policy. By refusing to accept the Privacy Policy, you lose access to the KOMFOVENT CONTROL application and your device data is deleted from the KOMFOVENT server unless it is anonymized or there are other reasons and legal basis for extended storage.

If you transfer ownership of the product, you shall inform the new owner of the Terms of Use of KOMFOVENT CONTROL.

KOMFOVENT may terminate your access to the KOMFOVENT CONTROL application by notifying you 90 days in advance about the termination of the KOMFOVENT CONTROL services or planned major changes to the program. KOMFOVENT may also terminate or limit your access to the KOMFOVENT CONTROL if you violate these Terms of Use.

7. Disclaimer

Internet access is required for the proper functioning and failure-free operation of the KOMFOVENT CONTROL application according to these Terms and Product User Guide. In rare cases, KOMFOVENT CONTROL or a part thereof may be unavailable due to, for example, program updates, Internet network problems or other malfunctions.

KOMFOVENT will make every effort to ensure that the KOMFOVENT CONTROL app is free from viruses and other threats, but cannot guarantee this. You shall be held responsible for using and maintaining antivirus software and other security features on your phone and for backing up your data.

If you receive an error message or notice the error yourself, please report it to KOMFOVENT. KOMFOVENT shall not be held liable for any direct or indirect loss incurred by you or others if the KOMFOVENT CONTROL app cannot continue to operate as expected.

8. Contact information and other

The remote service provider and data controller is KOMFOVENT, UAB, company code 124130658, registered address Ozo g. 10, LT-08200 Vilnius, e-mail: info@komfovent.com.

For more information about KOMFOVENT products and services visit www.komfovent.com.

LITHUANIA

UAB KOMFOVENT

TECHNINĖS PRIEŽIŪROS SKYRIUS / SERVICE AND SUPPORT

Phone: +370 5 200 8000

Email: service@komfovent.com

www.komfovent.com

RUSSIA

ООО «КОМФОВЕНТ»

Ул. Выборгская д. 16, стр. 1,
2 этаж, 206 офис, Москва, Россия

Тел. +7 499 673 22 73

info.ru@komfovent.com

www.komfovent.ru

ООО «КОМФОВЕНТ»

Рязское шоссе, 20 литера Е, пом Н6
390017 г. Рязань, Россия

Тел.: +7 491 255 95 71

info.ru@komfovent.com

www.komfovent.ru

BELARUS

ИООО «Комфовент»

ул. Уручская 21 – 423,
220125 г. Минск, Беларусь

Тел. +375 17 266 5297, 266 6327

info.by@komfovent.com

www.komfovent.by

SWEDEN

Komfovent AB

Ögärdesvägen 12B
433 30 Partille, Sverige

Тел. +46 31 487 752

info_se@komfovent.com

www.komfovent.se

FINLAND

Komfovent Oy

Muuntotie 1 C1
FI-01 510 Vantaa, Finland

Тел. +358 0 408 263 500

toimisto@komfovent.com

www.komfovent.com

PARTNERS

| | | |
|---------|----------------------------------|--|
| AT | J. PICHLER Gesellschaft m. b. H. | www.pichlerluft.at |
| BE | Ventilair group | www.ventilairgroup.com |
| | ACB Airconditioning | www.acbairco.be |
| CZ | REKUVENT s.r.o. | www.rekuvent.cz |
| CH | WESCO AG | www.wesco.ch |
| | SUDCLIMATAIR SA | www.sudclimatair.ch |
| CH / LI | CLIMAIR GmbH | www.climair.ch |
| | Trivent AG | www.trivent.com |
| DK | Øland A/S | www.oeland.dk |
| EE | BVT Partners | www.bvtpartners.ee |
| FR | ATIB | www.atib.fr |
| HR | Microclima | www.microclima.hr |
| | AIRVENT Légtechnikai Zrt. | www.airvent.hu |
| HU | Gevent Magyarország Kft. | www.gevent.hu |
| | Merkapt | www.merkapt.hu |
| IR | Fantech Ventilation Ltd | www.fantech.ie |
| IS | Blikk & Tækniþjónustan ehf | www.bogt.is |
| | Hitataekni ehf | www.hitataekni.is |
| IT | Icaria srl | www.icariavmc.it |
| NL | Ventilair group | www.ventilairgroup.com |
| | DECIPOL-Vortvent | www.vortvent.nl |
| | CLIMA DIRECT BV | www.climadirect.com |
| NO | Ventilution AS | www.ventilution.no |
| | Ventistål AS | www.ventistal.no |
| PL | Thermo Control AS | www.thermocontrol.no |
| | Ventia Sp. z o.o. | www.ventia.pl |
| SE | Nordisk Ventilator AB | www.nordiskventilator.se |
| SI | Agregat d.o.o | www.agregat.si |
| SK | TZB produkt, s.r.o. | www.tzbprodukt.sk |

GERMANY

Komfovent GmbH

Konrad-Zuse-Str. 2a,
42551 Velbert, Deutschland

Тел. +49 0 2051 6051180

info@komfovent.de

www.komfovent.de

LATVIA

SIA Komfovent

Bukaišu iela 1, LV-1004 Riga, Latvia

Тел. +371 24 66 4433

info@komfovent.lv

www.komfovent.lv

Vidzemes filiāle

Alejas iela 12A, LV-4219 Valmiermuiža,
Valmieras pagasts, Burtņieku novads

Тел. +371 29 358 145

kristaps.zaicevs@komfovent.com

www.komfovent.lv